

Edvo-Kit #

103

Edvo-Kit #103

Principles of PCR

Experiment Objective:

The objective of this experiment is to introduce students to the principles, practice and application of Polymerase Chain Reaction (PCR).

See page 3 for storage instructions.

Version 103.210628

EDVOTEK®

Table of Contents

	Page
Experiment Components	3
Experiment Requirements	3
Background Information	4
Experiment Procedures	
Experiment Overview	7
Module I: Agarose Gel Electrophoresis	9
Module II: Staining Agarose Gels Using FlashBlue™	11
Study Questions	12
Instructor's Guidelines	13
Pre-Lab Preparations	14
Experiment Results and Analysis	16
Study Questions and Answers	17
Appendices	18
A EDVOTEK® Troubleshooting Guide	19
B Bulk Preparation of Electrophoresis Buffer and Agarose Gels	20
C Using SYBR® Safe Stain (OPTIONAL)	21

Safety Data Sheets can be found on our website: www.edvotek.com/safety-data-sheets

Technical Support

1.800.EDVOTEK

Mon. - Fri. 8 AM to 5:30 PM EST



Please Have the Following Info:

- Product Number & Description
- Lot Number on Box
- Order/Purchase Order #

1.800.EDVOTEK • info@edvotek.com • www.edvotek.com

www.edvotek.com

- Online Catalog
- Order Products
- Experiment Protocols
- Tech Support
- Resources!



EDVOTEK and The Biotechnology Education Company are registered trademarks of EDVOTEK, Inc. Ready-to-Load, QuickStrip, FlashBlue, and UltraSpec-Agarose are trademarks of EDVOTEK, Inc. SYBR is a registered trademark of Thermo Fisher Scientific.



1.800.EDVOTEK • Fax 202.370.1501 • info@edvotek.com • www.edvotek.com

Duplication of any part of this document is permitted for non-profit educational purposes only. Copyright © 1989-2021 EDVOTEK, Inc., all rights reserved. Version 103.210628

Experiment Components

READY-TO-LOAD™ SAMPLES FOR ELECTROPHORESIS

Components (in QuickStrip™ format)

Store QuickStrip™ samples in the refrigerator upon receipt.

	Check (✓)
A DNA Standard Marker	<input type="checkbox"/>
B Control Sample after 0 Cycles	<input type="checkbox"/>
C Sample after 10 Cycles	<input type="checkbox"/>
D Sample after 30 Cycles	<input type="checkbox"/>
E Sample after 50 Cycles	<input type="checkbox"/>
F Sample Overnight	<input type="checkbox"/>

Experiment #103 is designed for 8 groups.

Store QuickStrip™ samples in the refrigerator immediately upon receipt. All other components can be stored at room temperature.

REAGENTS & SUPPLIES

Store the following at room temperature.

• UltraSpec-Agarose™	<input type="checkbox"/>
• Electrophoresis Buffer (50x)	<input type="checkbox"/>
• Practice Gel Loading Solution	<input type="checkbox"/>
• FlashBlue™ DNA Stain	<input type="checkbox"/>

Requirements

- Horizontal gel electrophoresis apparatus
- D.C. power supply
- Automatic micropipettes with tips
- Balance
- Microwave, hot plate or burner
- Pipet pump
- 250 mL flasks or beakers
- Hot gloves
- Safety goggles and disposable laboratory gloves
- Small plastic trays or large weigh boats (for gel destaining)
- DNA visualization system (white light)
- Distilled or deionized water

All experiment components are intended for educational research only. They are not to be used for diagnostic or drug purposes, nor administered to or consumed by humans or animals.

Background Information

Polymerase Chain Reaction (PCR) has had an extraordinary impact on various aspects of biotechnology. With PCR, DNA can be amplified and deciphered. This is analogous to a radio or stereo amplifier where radiowave signals, which are normally not heard, are amplified to become music to our ears. Since the first application of PCR (using the Klenow fragment) to detect sickle cell anemia, a large number of diagnostic tests have been developed. Many such diagnostic tests may soon become routine tests. Success of utilizing PCR is due to the specificity endowed in the hybridization properties of nucleic acids and the procedural simplicity. PCR has made amplification of DNA an alternate approach to cloning experiments. It is used in genome projects in DNA mapping and DNA sequencing. PCR amplification is also being applied to forensic and paternity determination, as well as determination of evolutionary relationships. In cases where DNA samples are limited, PCR amplifies DNA making further studies possible.

In a PCR reaction, the first step is the preparation of DNA extracted from various biological sources. The DNA or gene to be amplified is referred to as the target (Figure 1). A set of two primers usually ranging between 20 and 45 nucleotides are chemically synthesized to correspond to the two ends of the gene to be amplified. The primer concentrations are always in excess of the target gene to make possible subsequent priming. The nucleotide primer sequences for a specific amplification reaction are determined to yield the best hybridization.

The Klenow fragment of DNA Polymerase I (see section about DNA polymerases) was used in initial PCR experiments and was replaced subsequently by *Taq* DNA polymerase. This polymerase is thermally stable and therefore will not be denatured during the high temperature PCR steps. The source of *Taq* DNA polymerase and similar thermostable polymerases are thermophilic bacteria.

A typical PCR reaction mixture contains DNA, the four deoxynucleotide triphosphates, Mg^{+2} and *Taq* polymerase, all in the appropriate buffer. The total incubation reaction is usually 25 μ l or smaller in volume. The reaction mixture is then exposed to a three step temperature cycle which is repeated. The first temperature is 94 °C to melt the hydrogen bonds between the two strands of DNA. The temperature is then dropped to between 42 °C and 60 °C to hybridize the two primers on the two DNA target strands. The temperature is then increased to 72 °C, which is the optimum temperature for *Taq* polymerase (see Figure 1). These temperature cycles are usually repeated 20 to 40 times. This process is made efficient by placing the reaction microcentrifuge tubes in thermal cyclers which are programmed to alternate temperatures rapidly and effectively. The amplified DNA products are then separated by gel electrophoresis.

About DNA Polymerases

The DNA polymerase I is the first reported and best studied DNA polymerase. It is a single polypeptide with a molecular weight of 109,000 (approximately 1000 amino acids). It utilizes zinc as a metalloenzyme, possesses one disulfide bridge and one thiole group. A primed template, deoxynucleotide triphosphates, and magnesium are required for DNA synthesis. Polymerization of the nucleotides occurs in the 5' to 3' direction by the addition of a 5' phosphorylated nucleotide to the free 3' hydroxyl group of the growing DNA chain with the concomitant production of pyrophosphate.

The specificity of nucleotide incorporation is dictated by the Watson - Crick base pairing rules and is directed by the template DNA (Figure 2). The strand being synthesized is complimentary and antiparallel to the template DNA strand. DNA synthesis catalyzed by DNA polymerase cannot occur without a primer having a free 3' terminal hydroxyl group. The primer is antiparallel and is base paired to the template strand. DNA replication is much more complex. RNA fragments containing about 10 nucleotides serve to prime DNA synthesis. Primer RNAs are synthesized by the enzyme primase which is a specialized DNA dependent RNA polymerase.



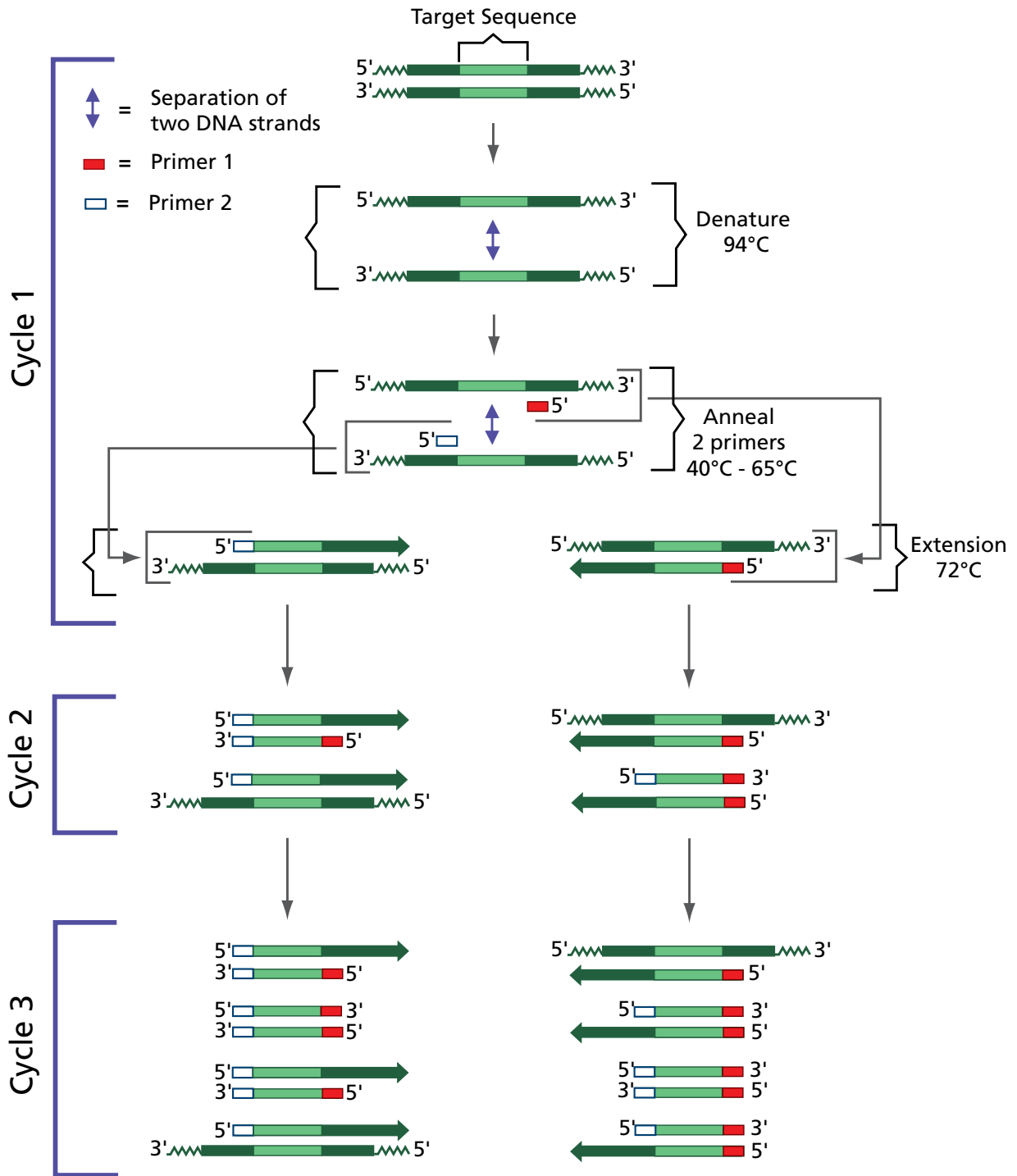

Figure 1:
 DNA Amplification by the Polymerase
 Chain Reaction

Like most DNA polymerases, DNA polymerase I also contains a 3' to 5' proofreading activity. This activity will recognize distortions in the 3' ends of the growing chain caused by mismatched bases between template and the growing chain resulting in unpaired bases and will correct such errors in base pairing.

Limited proteolysis of DNA polymerase I with proteases such as subtilisin or trypsin produces two polypeptide fragments having molecular weights of 76,000 and 36,000. The larger polypeptide, known as the Klenow fragment contains the polymerization and 3'-5' exonuclease activities while the smaller fragment contains the 5'-3' exonuclease. The Klenow fragment was historically used for DNA synthesis, DNA sequencing and polymerase chain reaction (PCR) experiments.

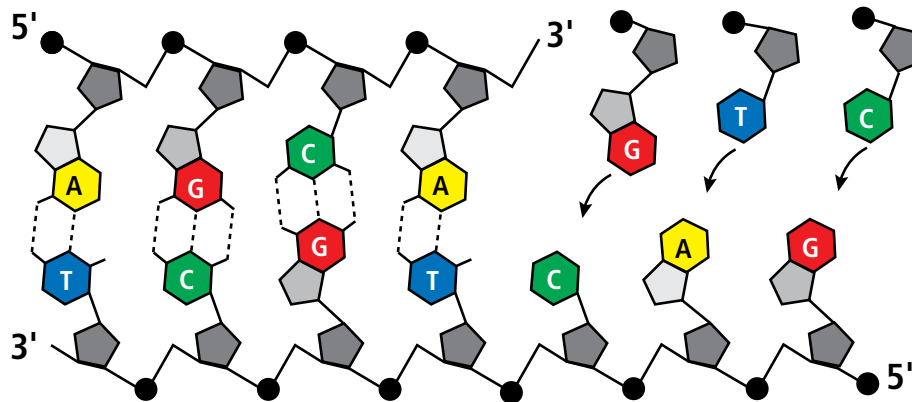

Figure 2

Experiment Overview

EXPERIMENT OBJECTIVE

The objective of this experiment is to introduce students to the principles, practice and application of Polymerase Chain Reaction (PCR).

LABORATORY SAFETY

1. Gloves and goggles should be worn routinely as good laboratory practice.
2. Exercise extreme caution when working with equipment that is used in conjunction with the heating and/or melting of reagents.
3. DO NOT MOUTH PIPET REAGENTS - USE PIPET PUMPS.
4. Exercise caution when using any electrical equipment in the laboratory.
5. Always wash hands thoroughly with soap and water after handling reagents or biological materials in the laboratory.



LABORATORY NOTEBOOKS

Scientists document everything that happens during an experiment, including experimental conditions, thoughts and observations while conducting the experiment, and, of course, any data collected. Today, you'll be documenting your experiment in a laboratory notebook or on a separate worksheet.

Before starting the Experiment:

- Carefully read the introduction and the protocol. Use this information to form a hypothesis for this experiment.
- Predict the results of your experiment.

During the Experiment:

- Record your observations.

After the Experiment:

- Interpret the results – does your data support or contradict your hypothesis?
- If you repeated this experiment, what would you change? Revise your hypothesis to reflect this change.

Experiment Overview

MODULE I: Agarose Gel Electrophoresis

Time required: See Table C

Quick Reference for EDVO-Kit #103			
Size of gel casting tray	Groups per gel	Placement of comb	Wells required per group
7 x 7 cm	1 group	1st set of notches	6
10 x 7 cm	1 group	1st set of notches	6
14 x 7 cm	2 groups	1st and 3rd sets of notches	6

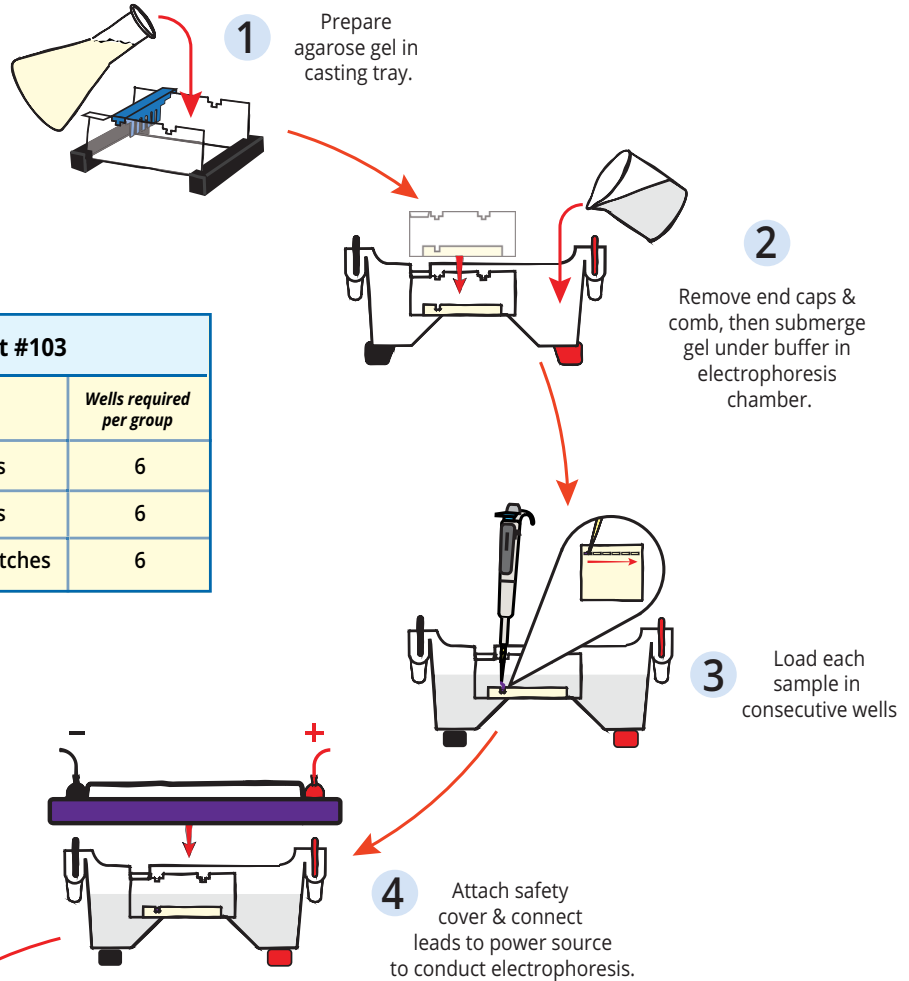

MODULE II: Staining Agarose Gels Using FlashBlue™

Time required: 30 min.

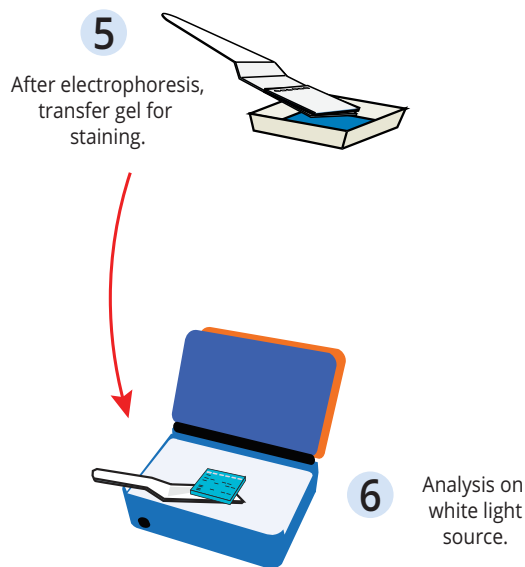

Related EDVOTEK® Instructional Videos

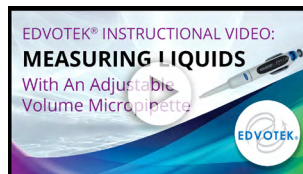

www.youtube.com/edvotekinc

Module I: Agarose Gel Electrophoresis

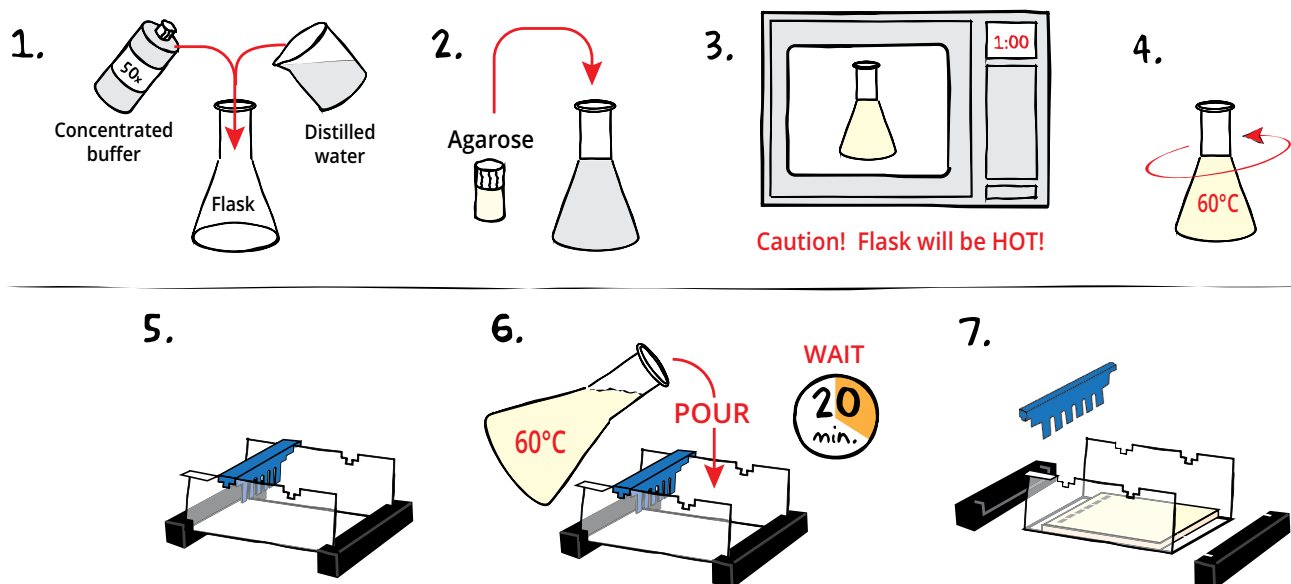

CASTING THE AGAROSE GEL

- DILUTE** concentrated 50X Electrophoresis buffer with distilled water (refer to Table A for correct volumes depending on the size of your gel casting tray).
- MIX** agarose powder with buffer solution in a 250 mL flask (refer to Table A).
- DISSOLVE** agarose powder by boiling the solution. **MICROWAVE** the solution on high for 1 minute. Carefully **REMOVE** the flask from the microwave and **MIX** by swirling the flask. Continue to **HEAT** the solution in 15-second bursts until the agarose is completely dissolved (the solution should be clear like water).
- COOL** agarose to 60 °C with careful swirling to promote even dissipation of heat.
- While agarose is cooling, **SEAL** the ends of the gel-casting tray with the rubber end caps. **PLACE** the well template (comb) in the appropriate notch.
- POUR** the cooled agarose solution into the prepared gel-casting tray. The gel should thoroughly solidify within 20 minutes. The gel will stiffen and become less transparent as it solidifies.
- REMOVE** end caps and comb. Take particular care when removing the comb to prevent damage to the wells.



Wear gloves and safety goggles

REMINDER:

This experiment requires 0.8% agarose gels cast with 6 wells.

Size of Gel Casting tray	Concentrated Buffer (50x)	+ Distilled Water	+ Amt of Agarose	= TOTAL Volume
7 x 7 cm	0.6 mL	29.4 mL	0.24 g	30 mL
10 x 7 cm*	0.9 mL	44.1 mL	0.36 g	45 mL
14 x 7 cm	1.2 mL	58.8 mL	0.48 g	60 mL

*Recommended gel volume for the EDGE™ Integrated Electrophoresis System. (Cat. #500).

Module I: Agarose Gel Electrophoresis

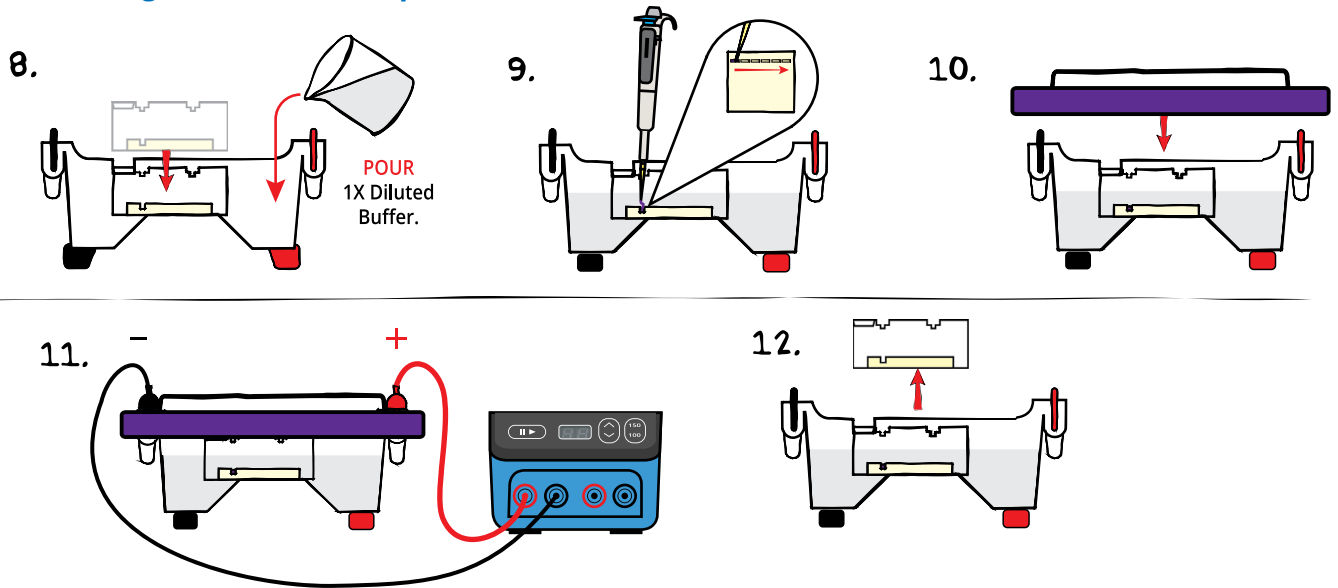

RUNNING THE GEL

8. **PLACE** the gel (still on the tray*) into the electrophoresis chamber. **COVER** the gel with 1X Electrophoresis Buffer (See Table B for recommended volumes). The gel should be completely submerged.
9. **PUNCTURE** the foil overlay of the QuickStrip™ with a pipet tip. **LOAD** the entire sample (35 µL) into the well in the order indicated by Table 1, at right.
10. **PLACE** safety cover on the unit. **CHECK** that the gel is properly oriented. Remember, the DNA samples will migrate toward the positive (red) electrode.
11. **CONNECT** leads to the power source and **PERFORM** electrophoresis (See Table C for time and voltage guidelines). Allow the tracking dye to migrate at least 3 cm from the wells.
12. After electrophoresis is complete, **REMOVE** the gel and casting tray from the electrophoresis chamber.

REMINDER:
Before loading the samples, make sure the gel is properly oriented in the apparatus chamber.

Lane	Tube	Sample
1	Tube A	DNA Standard Marker
2	Tube B	Control Sample after 0 Cycles
3	Tube C	Sample after 10 Cycles
4	Tube D	Sample after 30 Cycles
5	Tube E	Sample after 50 Cycles
6	Tube F	Sample overnight

EDVOTEK Model #	Total Volume Required	Dilution	
		50x Conc. Buffer	+ Distilled Water
EDGE™	150 mL	3 mL	147 mL
M12	400 mL	8 mL	392 mL
M36	1000 mL	20 mL	980 mL

Volts	Electrophoresis Model	
	EDGE™	M12 & M36
	Min/Max (minutes)	Min/Max (minutes)
150	10/20	20/35
125	N/A	30/45
100	15/25	40/60

PROCEED to Module II: Staining Agarose Gels Using FlashBlue™.

*Gels that have previously been removed from their trays should be “anchored” back to the tray with a few drops of molten agarose before placing into the electrophoresis chamber. This will prevent the gels from sliding around in the trays and the chambers.

Module II: Staining Agarose Gels Using FlashBlue™

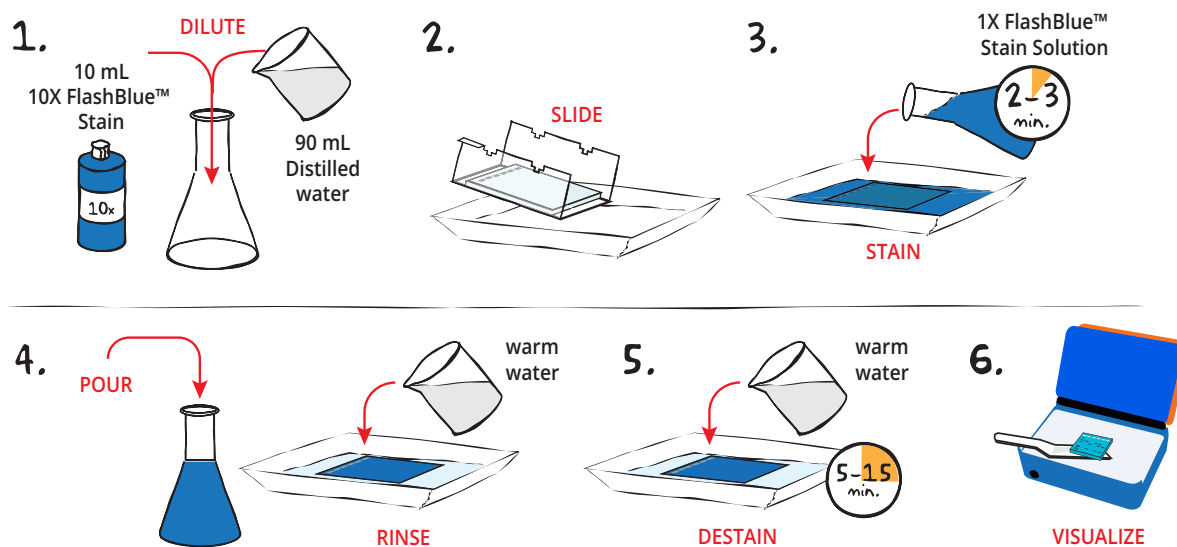

- DILUTE** 10 mL of 10X concentrated FlashBlue™ with 90 mL of distilled water in a flask. **MIX** well.
- REMOVE** the agarose gel and casting tray from the electrophoresis chamber. **SLIDE** the gel off the casting tray into a small, clean gel-staining tray.
- COVER** the gel with the 1X FlashBlue™ stain solution. **STAIN** the gel for 2-3 minutes. For best results, use an orbital shaker to gently agitate the gel while staining. **STAINING THE GEL FOR LONGER THAN 3 MINUTES WILL REQUIRE EXTRA DESTAINING TIME.**
- POUR** the 1X FlashBlue™ back into the flask (the stain can be reused). **COVER** the gel with warm water (40-45 °C). Gently **RINSE** the gel for 20-30 seconds. **POUR** off the water.
- COVER** the gel with clean, warm water (40-45 °C). **DESTAIN** for 5-15 minutes with gentle shaking (longer periods will yield better results). DNA bands will start to appear after 5 minutes of destaining. Changing the water frequently will accelerate destaining.
- Carefully **REMOVE** the gel from the destaining liquid. **VISUALIZE** results using a white light visualization system. DNA will appear as dark blue bands on a light blue background.



ALTERNATIVE FLASHBLUE™ STAINING PROTOCOL:

- DILUTE** 1 mL of 10X FlashBlue™ stain with 149 mL distilled water.
- COVER** the gel with diluted FlashBlue™ stain.
- SOAK** the gel in the staining liquid for at least three hours. For best results, stain gels overnight.
- Carefully **REMOVE** the gel from the staining liquid. **VISUALIZE** results using a white light visualization system. DNA will appear as dark blue bands on a light blue background.

Study Questions

1. Why is proofreading by the 3' to 5' exonuclease activity of DNA polymerase I during DNA synthesis very important?
2. How does one achieve limited protease digestion?
3. Why are two different primers required for the PCR reaction?
4. Why does *Taq* polymerase survive the temperature changes in PCR, including the 94 °C step?

Instructor's Guide

ADVANCE PREPARATION:

PREPARATION FOR:	WHAT TO DO:	WHEN?	TIME REQUIRED:
Module I: Agarose Gel Electrophoresis	Prepare QuickStrips™.	Up to one day before performing the experiment.	45 min.
	Prepare diluted electrophoresis buffer.		
	Prepare molten agarose and pour gels.		
Module II: Staining Agarose Gels Using FlashBlue™	Prepare staining components.	The class period or overnight after the class period.	10 min.

Technical Support

1.800.EDVOTEK

Mon. - Fri. 8 AM to 5:30 PM EST



Please Have the Following Info:

- Product Number & Description
- Lot Number on Box
- Order/Purchase Order #

1.800.EDVOTEK • info@edvotek.com • www.edvotek.com

www.edvotek.com

- Online Catalog
- Order Products
- Experiment Protocols
- Tech Support
- Resources!



Pre-Lab Preparations: Module I

AGAROSE GEL ELECTROPHORESIS

This experiment requires 0.8% agarose gels. Enough reagents are provided to cast either eight 7 x 7 cm gels, eight 10 x 7 cm gels, or four 14 x 7 cm gels. You can choose whether to prepare the gels in advance or have students prepare their own. Allow approximately 30 minutes for this procedure.

Quick Reference for EDVO-Kit #103			
Size of gel casting tray	Groups per gel	Placement of comb	Wells required per group
7 x 7 cm	1 group	1st set of notches	6
10 x 7 cm	1 group	1st set of notches	6
14 x 7 cm	2 groups	1st and 3rd sets of notches	6

Individual Gel Preparation:

Each student group can be responsible for casting their own individual gel prior to conducting the experiment. See Module I in the Student's Experimental Procedure. Students will need 50x concentrated buffer, distilled water and agarose powder.

Batch Gel Preparation:

To save time, a larger quantity of agarose solution can be prepared for sharing by the class. Electrophoresis buffer can also be prepared in bulk. See Appendix B.

Preparing Gels in Advance:

Gels may be prepared ahead and stored for later use. Solidified gels can be stored under buffer in the refrigerator for up to 2 weeks.

Do not freeze gels at -20 °C as freezing will destroy the gels.

Gels that have been removed from their trays for storage should be "anchored" back to the tray with a few drops of molten agarose before being placed into the tray. This will prevent the gels from sliding around in the trays and the chambers.

SAMPLES FORMAT: PREPARING THE QUICKSTRIPS™

QuickStrip™ tubes consist of a microtiter block covered with a protective foil overlay. Each well contains pre-aliquoted sample.

Using sharp scissors, carefully divide the block of tubes into individual strips by cutting between the rows (see diagram at right). Take care not to damage the foil overlay while separating the samples.

Each lab group will receive one set of tubes. Before loading the gel, remind students to tap the tubes to collect the sample at the bottom of the tube. Puncture the foil overlay of the QuickStrip™ with a pipet tip to aspirate the sample. **Do not remove the foil as samples can spill.**

FOR MODULE I Each group will need:

- 50x concentrated buffer
- Distilled Water
- UltraSpec-Agarose™
- QuickStrip™ Samples

NOTE:

This kit is compatible with [SYBR® Safe Stain](#) (Cat #608, not included). Instructions for preparing gels and visualizing results can be found in Appendix C.

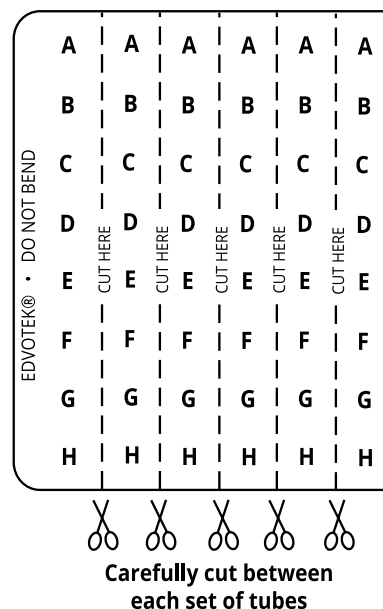

Pre-Lab Preparations: Module II

STAINING AGAROSE GELS USING FLASHBLUE™

FlashBlue™ stain is optimized to shorten the time required for both staining and destaining steps. Agarose gels can be stained with diluted FlashBlue™ for 5 minutes and destained for only 20 minutes. For the best results, leave the gel in liquid overnight. This will allow the stained gel to “equilibrate” in the destaining solution, resulting in dark blue DNA bands contrasting against a uniformly light blue background. A white light box ([Cat. #552](#)) is recommended for visualizing gels stained with FlashBlue™.

- Stained gels may be stored in destaining liquid for several weeks with refrigeration, although the bands may fade with time. If this happens, re-stain the gel.
- Destained gels can be discarded in solid waste disposal. Destaining solutions can be disposed of down the drain.

FOR MODULE II Each group will need:

- 10 mL 10X concentrated FlashBlue **OR**
100 mL 1x diluted FlashBlue
- Small plastic tray or weight boat
- Distilled or deionized water

PHOTODOCUMENTATION OF DNA (OPTIONAL)

Once gels are stained, you may wish to photograph your results. There are many different photodocumentation systems available, including digital systems that are interfaced directly with computers. Specific instructions will vary depending upon the type of photodocumentation system you are using.

NOTE:

Accurate pipetting is critical for maximizing successful experiment results. EDVOTEK Series 100 experiments are designed for students who have had previous experience with micropipetting techniques and agarose gel electrophoresis.

If students are unfamiliar with using micropipettes, we recommended performing [Cat. #S-44, Micropipetting Basics](#) or [Cat. #S-43, DNA DuraGel™](#) prior to conducting this experiment.

Experiment Results and Analysis

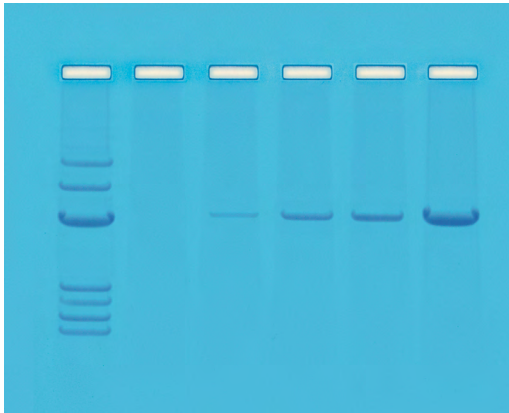

Includes EDVOTEK's All-NEW DNA Standard Marker

- Better separation
- Easier band measurements
- No unused bands

NEW DNA Standard ladder sizes:
6751, 3652, 2827, 1568, 1118, 825, 630



In the idealized schematic, the relative positions of DNA fragments are shown but are not depicted to scale.

Lane	Tube	Sample	Molecular Weights (in bp)
1	A	DNA Standard Markers	6751, 3652, 2827, 1568 1118, 825, 630
2	B	Control reaction sample after 0 cycles	No bands
3	C	Reaction sample after 10 cycles	2999
4	D	Reaction sample after 30 cycles	2999
5	E	Reaction sample after 50 cycles	2999
6	F	Reaction sample overnight	2999

**Please refer to the kit
insert for the Answers to
Study Questions**

Appendices

- A EDVOTEK® Troubleshooting Guide
- B Bulk Preparation of Electrophoresis Buffer and Agarose Gels
- C Using SYBR® Safe Stain (OPTIONAL)

Safety Data Sheets can be found on our website: www.edvotek.com/safety-data-sheets

Technical Support

1.800.EDVOTEK

Mon. - Fri. 8 AM to 5:30 PM EST



Please Have the Following Info:

- Product Number & Description
- Lot Number on Box
- Order/Purchase Order #

1.800.EDVOTEK • info@edvotek.com • www.edvotek.com

www.edvotek.com

- Online Catalog
- Order Products
- Experiment Protocols
- Tech Support
- Resources!



Appendix A

EDVOTEK® Troubleshooting Guides

PROBLEM:	CAUSE:	ANSWER:
Bands are not visible on the gel.	The gel was not prepared properly.	Ensure that the electrophoresis buffer was correctly diluted.
	The gel was not stained properly.	Repeat staining protocol.
	Malfunctioning electrophoresis unit or power source.	Contact the manufacturer of the electrophoresis unit or power source.
After staining the gel, the DNA bands are faint.	The gel was not stained for a sufficient period of time.	Repeat staining protocol.
	The background of gel is too dark after staining with FlashBlue™.	Destain the gel for 5-10 minutes in distilled water.
DNA bands were not resolved.	Tracking dye should migrate at least 3 cm from the wells to ensure adequate separation.	Be sure to run the gel at least 3 cm before staining and visualizing the DNA (approximately 15-20 minutes at 150 V).
DNA bands fade when gels are kept at 4 °C.	DNA stained with FlashBlue™ may fade with time.	Re-stain the gel with FlashBlue™.
There is no separation between DNA bands, even though the tracking dye ran the appropriate distance.	The wrong percent gel was used for electrophoretic separation.	Be sure to prepare the correct percent agarose gel. For reference, the Ready-to-Load™ DNA samples should be analyzed using a 0.8% agarose gel.
There's not enough sample in my QuickStrip™.	The QuickStrip™ has dried out.	Add 40 µL water, gently pipet up and down to mix before loading.

Visit www.edvotek.com for additional troubleshooting suggestions.

Appendix B

Bulk Preparation of Electrophoresis Buffer and Agarose Gels

To save time, the electrophoresis buffer and agarose gel solution can be prepared in larger quantities for sharing by the class. Unused diluted buffer can be used at a later time and solidified agarose gel solution can be remelted.

Bulk Electrophoresis Buffer

Quantity (bulk) preparation for 3 liters of 1x electrophoresis buffer is outlined in Table D.

Table D Bulk Preparation of Electrophoresis Buffer			
50x Conc. Buffer	+	Distilled Water	Total Volume Required
60 mL		2,940 mL	3000 mL (3 L)

Batch Agarose Gels (0.8%)

For quantity (batch) preparation of 0.8% agarose gels, see Table E.

1. Use a 500 mL flask to prepare the diluted gel buffer.
2. Pour 3.0 grams of UltraSpec-Agarose™ into the prepared buffer. Swirl to disperse clumps.
3. With a marking pen, indicate the level of solution volume on the outside of the flask.
4. Heat the agarose solution as outlined previously for individual gel preparation. The heating time will require adjustment due to the larger total volume of gel buffer solution.
5. Cool the agarose solution to 60 °C with swirling to promote even dissipation of heat. If evaporation has occurred, add distilled water to bring the solution up to the original volume as marked on the flask in step 3.
6. Dispense the required volume of cooled agarose solution for casting each gel. Measure 30 mL for a 7 x 7 cm tray, 45 mL for a 10 x 7 cm tray, and 60 mL for a 14 x 7 cm tray. **For this experiment, 7 x 7 cm gels are recommended.**
7. Allow the gel to completely solidify. It will become firm and cool to the touch after approximately 20 minutes. Solidified gels can be stored under buffer in the refrigerator for up to 2 weeks. Do not freeze gels.

Table E Batch Prep of 0.8% UltraSpec-Agarose™					
Amt of Agarose	+	Concentrated Buffer (50X)	+	Distilled Water	Total Volume
3.0 g		7.5 mL		367.5 mL	375 mL

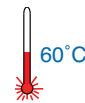

NOTE:

The UltraSpec-Agarose™ kit component is usually labeled with the amount it contains. Please read the label carefully. If the amount of agarose is not specified or if the bottle's plastic seal has been broken, weigh the agarose to ensure you are using the correct amount.

PROCEED to Loading and Running the Gel (page 10).

Appendix C

Using SYBR® Safe DNA Stain (OPTIONAL)

If desired, the DNA samples in this experiment can be visualized using [SYBR® Safe DNA stain \(Cat #608\)](#).

We recommend adding diluted SYBR® Safe stain to the liquid agarose gels while casting for easy, reproducible results. A blue light or UV transilluminator is needed for visualizing SYBR® gels. The TruBlu™ 2 ([Cat. #557](#)) is highly recommended.

PREPARING SYBR® SAFE STAIN

Instructors:

1. Prepare 1x Electrophoresis Buffer by combining 10 µL of 50X Concentrated Buffer with 490 µL of distilled water.
2. Add 20 µL of the SYBR® Safe to the tube of 1X buffer from Step 1 and mix by tapping the tube several times. The diluted SYBR® Safe Stain is now ready to be used during agarose gel preparation.

AGAROSE GEL PREPARATION

This experiment requires one 0.8% agarose gel for each student group. Instructors can choose whether to prepare the gels in advance (METHOD A) or have the students prepare their own (METHOD B). Allow approximately 30-40 minutes for this procedure.

Instructor Preparation (METHOD A):

For quantity (batch) preparation of agarose gels, see Table E.

1. Use a 500 mL flask to prepare the diluted gel buffer.
2. Pour 3.0 grams of UltraSpec-Agarose™ into the prepared buffer. Swirl to disperse clumps.
3. With a marking pen, indicate the level of solution volume on the outside of the flask.
4. Heat the agarose solution as outlined previously for individual gel preparation. The heating time will require adjustment due to the larger total volume of gel buffer solution.
5. Cool the agarose solution to 60 °C with swirling to promote even dissipation of heat. If evaporation has occurred, add distilled water to bring the solution up to the original volume as marked on the flask in step 3.
6. Add the entire tube of **diluted SYBR® Safe** stain to the cooled agarose and mix well.
7. Dispense the required volume of cooled agarose solution for casting each gel. Measure 30 mL for a 7 x 7 cm tray, 45 mL for a 10 x 7 cm tray, and 60 mL for a 14 x 7 cm tray. **For this experiment, 7 x 7 cm gels are recommended.**
8. Allow the gel to completely solidify. It will become firm and cool to the touch after approximately 20 minutes. Solidified gels can be stored in the refrigerator for up to 2 weeks. Place 1-2 mL of electrophoresis buffer in a sealable bag with the gels to prevent them from drying out. Excessive buffer will cause SYBR® Safe to diffuse out of the gels. Do not freeze gels.

PROCEED to Loading and Running the Gel (Steps 8-12 on page 10), followed by the VISUALIZATION procedures on page 23.

NO ADDITIONAL STAINING IS NECESSARY.

Table E € Batch Prep of 0.8% UltraSpec-Agarose™					
Amt of Agarose	+	Concentrated Buffer (50X)	+	Distilled Water	Total Volume
3.0 g		7.5 mL		367.5 mL	375 mL

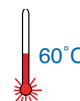

Appendix C

Using SYBR® Safe DNA Stain (OPTIONAL)

AGAROSE GEL PREPARATION, CONTINUED

Student Preparation (METHOD B):

For student preparation of agarose gels, see Table A.2.

1. **DILUTE** concentrated (50X) buffer with distilled water to create 1X buffer (see Table A.2).
2. **MIX** agarose powder with 1X buffer in a 250 mL flask (see Table A).
3. **DISSOLVE** agarose powder by boiling the solution. **MICROWAVE** the solution on high for 1 minute. Carefully **REMOVE** the flask from the microwave and **MIX** by swirling the flask. Continue to **HEAT** the solution in 15-second bursts until the agarose is completely dissolved (the solution should be clear like water).
4. **COOL** agarose to 60 °C with careful swirling to promote even dissipation of heat. 
5. While agarose is cooling, **SEAL** the ends of the gel-casting tray with the rubber end caps. **PLACE** the well template (comb) in the appropriate notch.
6. Before casting the gel, **ADD diluted SYBR® Safe** to the cooled agarose and swirl to mix (see Table A.2).
7. **POUR** the cooled agarose solution into the prepared gel-casting tray. The gel should thoroughly solidify within 20 minutes. The gel will stiffen and become less transparent as it solidifies.
8. **REMOVE** end caps and comb. Take particular care when removing the comb to prevent damage to the wells.

Size of Gel Casting tray	Concentrated Buffer (50x)	Distilled Water	Amt of Agarose	TOTAL Volume	Diluted SYBR® (Step 6)
7 x 7 cm	0.6 mL	29.4 mL	0.24 g	30 mL	30 µL
10 x 7 cm*	0.9 mL	44.1 mL	0.36 g	45 mL	45 µL
14 x 7 cm	1.2 mL	58.8 mL	0.48 g	60 mL	60 µL

* Recommended gel volume for the EDGE™ Integrated Electrophoresis System.

PROCEED to Loading and Running the Gel (Steps 8-12 on page 10), followed by the VISUALIZATION procedures on page 23. **NO ADDITIONAL STAINING IS NECESSARY.**

Appendix C

Using SYBR® Safe DNA Stain (OPTIONAL)

VISUALIZING THE SYBR® GEL

A blue light or UV transilluminator is needed for visualizing SYBR® gels. The TruBlu™ 2 ([Cat. #557](#)) is highly recommended.

1.



2.



3.



1. **SLIDE** gel off the casting tray onto the viewing surface of the transilluminator.
2. Turn the unit **ON**. DNA should appear as bright green bands on a dark background. **PHOTOGRAPH** results.
3. Turn the unit **OFF**. **REMOVE** and **DISPOSE** of the gel. **CLEAN** the transilluminator surfaces with distilled water.

