

THE BIOTECHNOLOGY  
EDUCATION COMPANY®

REVISED  
&  
UPDATED

Edvo-Kit #

962

Edvo-Kit #962

## Identification of Genetically Modified Foods Using PCR

### Experiment Objective:

The objective of this experiment is to utilize PCR to identify genetically modified foods.

See page 3 for storage instructions.

LyphoPrimer™

LyphoControl™

### IMPORTANT NOTE:

The PCR cycling conditions and electrophoresis buffer have changed. Please review the literature before performing the experiment.

# Table of Contents

	<b>Page</b>
Experiment Components	3
Experiment Requirements	4
Background Information	5
Experiment Procedures	
Experiment Overview	9
Module I: Isolation of DNA from Food	10
Module II: PCR Amplification	12
Module III: Separation of PCR Products by Electrophoresis	13
Study Questions	16
Instructor's Guidelines	17
Pre-Lab Preparations	18
Experiment Results and Analysis	21
Study Questions and Answers	22
Appendices	23
A EDVOTEK® Troubleshooting Guide	24
B Bulk Preparation of Electrophoresis Buffer and Agarose Gels	26

Safety Data Sheets can be found on our website: [www.edvotek.com/Safety-Data-Sheets](http://www.edvotek.com/Safety-Data-Sheets)

## EDVO-TECH Service

**1.800.EDVOTEK**

Mon. - Fri. 8am-5:30pm EST



### Please Have the Following Info:

- Product Number & Description
- Lot Number on Box
- Order/Purchase Order #
- Approx. Purchase Date

Fax: 202.370.1501 • [info@edvotek.com](mailto:info@edvotek.com) • [www.edvotek.com](http://www.edvotek.com)

[www.edvotek.com](http://www.edvotek.com)

- Online Catalog
- Order Products
- Experiment Protocols
- Tech Support
- Resources!



1.800.EDVOTEK • Fax 202.370.1501 • [info@edvotek.com](mailto:info@edvotek.com) • [www.edvotek.com](http://www.edvotek.com)

Duplication of any part of this document is permitted for non-profit educational purposes only. Copyright © 1989-2018 EDVOTEK, Inc., all rights reserved. 962.181010

## Experiment Components

Components	Storage	Check (✓)
<ul style="list-style-type: none"> <li>PCR EdvoBeads™ PLUS <i>(Each PCR EdvoBead™ PLUS contains: dNTP Mixture, Taq DNA Polymerase Buffer, Taq DNA Polymerase, and MgCl<sub>2</sub>)</i></li> </ul>	Room Temp.	<input type="checkbox"/>
A Universal DNA Buffer	-20° C Freezer	<input type="checkbox"/>
B TE Buffer	-20° C Freezer	<input type="checkbox"/>
C LyphoPrimer™ Mix	-20° C Freezer, desiccated	<input type="checkbox"/>
D GMO Positive LyphoControl™ <i>(Complete PCR Control)</i>	-20° C Freezer, desiccated	<input type="checkbox"/>
E NaCl Solution	-20° C Freezer	<input type="checkbox"/>
F DNA Extraction Buffer	-20° C Freezer	<input type="checkbox"/>
G 100 base pair ladder	-20° C Freezer	<input type="checkbox"/>
<ul style="list-style-type: none"> <li>Proteinase K</li> </ul>	-20° C Freezer, desiccated	<input type="checkbox"/>

**This experiment is designed for 25 reactions.**

All experiment components are intended for educational research only. They are not to be used for diagnostic or drug purposes, nor administered to or consumed by humans or animals.

Sample volumes are very small. For liquid samples, it is important to quickly spin the tube contents in a microcentrifuge to obtain sufficient volume for pipetting. Spin samples for 10-20 seconds at maximum speed.

### REAGENTS & SUPPLIES

Store all components below at room temperature.

Component	Check (✓)
<ul style="list-style-type: none"> <li>UltraSpec-Agarose™</li> <li>TBE Electrophoresis Buffer Powder</li> <li>SYBR® Safe Stain</li> <li>0.2 mL PCR Tubes</li> <li>Plastic Micropestles</li> <li>Transfer Pipets</li> <li>Snap-top Microcentrifuge Tubes</li> </ul>	<input type="checkbox"/> <input type="checkbox"/> <input type="checkbox"/> <input type="checkbox"/> <input type="checkbox"/> <input type="checkbox"/> <input type="checkbox"/>

EDVOTEK and The Biotechnology Education Company are registered trademarks of EDVOTEK, Inc. SYBR is a registered trademark of Thermo Fisher Scientific. PCR EdvoBead, LyphoControl, LyphoPrimer, and UltraSpec-Agarose are trademarks of EDVOTEK, Inc.

1.800.EDVOTEK • Fax 202.370.1501 • [info@edvotek.com](mailto:info@edvotek.com) • [www.edvotek.com](http://www.edvotek.com)

Duplication of any part of this document is permitted for non-profit educational purposes only. Copyright © 1989-2018 EDVOTEK, Inc., all rights reserved. 962.181010



## Requirements

---

- Recommended foodstuffs that have worked well in the EDVOTEK testing laboratory include: Corn bread, corn meal, and papaya. See page 18 for more information.
- Thermal cycler (EDVOTEK Cat. #541 highly recommended)
- Horizontal gel electrophoresis apparatus
- D.C. power supply
- Balance
- Microcentrifuge
- Water bath 56° C (EDVOTEK Cat. #539 highly recommended)
- UV Transilluminator or Blue Light visualization (EDVOTEK Cat. #557 or #558 highly recommended)
- UV safety goggles
- Automatic micropipettes (5-50 µL) with tips
- Microwave
- Pipet pump
- 250 mL flasks or beakers
- Hot gloves
- Safety goggles
- Disposable vinyl or latex laboratory gloves
- Ice buckets and ice
- Distilled or deionized water
- Isopropanol
- 70% Ethanol



## Background Information

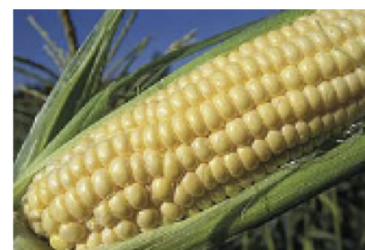
### WHAT ARE GENETICALLY MODIFIED ORGANISMS?

Over the past one hundred years, genetic research has expanded our understanding of the genome (the hereditary material of an organism encoded by its DNA) and its role as a blueprint for all processes within an organism. Variations in the DNA sequence, called mutations, can cause changes in the way an organism interacts with its environment. Most mutations result in negative effects for the organism; occasionally, a mutation grants an organism an advantage that promotes survival in its particular environment.

Humans have long recognized and taken advantage of genetic variation through traditional plant and animal husbandry techniques. For centuries, selective breeding and conventional hybridization have been used to increase crops' yields or give rise to other desirable qualities. For example, the corn we eat today was produced by artificial selection. Ages ago, farmers may have noticed that one plant was producing larger kernels, while another plant was producing more flavorful corn (Figure 1A). By crossing the two plants, these farmers encouraged those traits (observable characteristics) in the next generation. This allowed farmers to grow plants that yielded the best possible product — a plant with many ears of large, delicious kernels of corn (Figure 1B). In this way, over the last fifty years—a period during which the world population more than doubled, but farmland only increased by 10%—selective breeding and new agricultural technologies have allowed food yields to increase 25% per person!

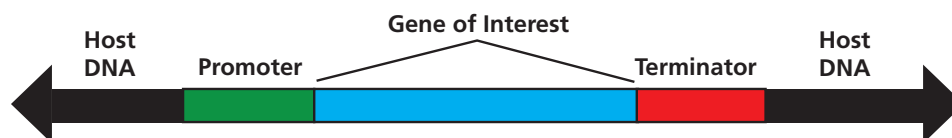


**Figure 1A:** Traditional varieties of corn.



**Figure 1B:** Cultivated corn.

While it used to take years of selective breeding to produce the genomic changes necessary to give rise to such desirable traits, modern biotechnology techniques have accelerated this pace. Genetic engineering now allows scientists to directly manipulate a DNA sequence to generate desirable traits. These engineered genes, called transgenes, can be inserted, deleted or mutated in a matter of weeks using recombinant DNA technology. To be properly expressed *in vivo*, a transgene must include a promoter sequence, which recruits RNA polymerase to the transgene for transcription, and a terminator sequence, which signals RNA polymerase to end transcription (Figure 2).



**Figure 2:** Features of a Transgene.

Many technologies have been developed to create transgenic plants. One example is the biolistic (or “gene gun”) method. Using this approach, the transgene DNA is adhered to gold particles and then shot through the walls of plant embryonic stem cells. After the treatment, researchers screen the cells for markers that show the transgene has been incorporated into the plant genome. The transgenic stem cells are used to create mature plants. Another method relies on a natural plant parasite (*Agrobacterium tumefaciens*) that transfers some of its own genetic material into plant cells as the Ti-plasmid. Genetic engineers use recombinant DNA technology to replace

a bacterial gene with a gene of interest. The bacteria transfer the transgene to the host as part of the Ti-plasmid, thus creating a transgenic plant. This technique works best with plants like tomatoes, apples and soybeans.

Some of the first genetically modified plants simplified pest management for farmers. *Bacillus thuringiensis*, a gram-positive bacterium, had long been used in organic farming for its insecticidal proteins. The bacterial spores needed to be sprayed on the crops several times during the growing season to protect the plants from insect damage. To simplify this treatment, scientists used several of the bacterial genes to create “Bt-corn”, a crop that expresses the insecticidal proteins to protect the plant from pest damage (Figure 3). This technology allows farmers to use less chemical pesticides, some of which are harmful to people and to the environment.

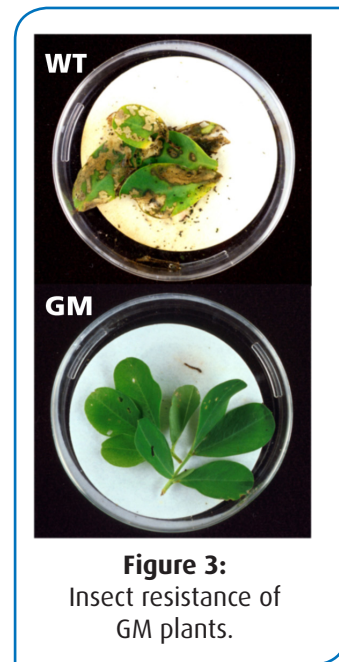
Current plant biotechnology also promises to increase the quality of food crops. One application of biotechnology to food science is antisense RNA technology, which can be used to decrease food spoilage. This technique takes advantage of the natural process of RNA silencing to reduce expression levels of naturally occurring genes. For example, the enzyme polygalacturonase (PG) digests pectin in the tomato’s cell wall, making the fruit softer and more susceptible to fungal infections. The Flavr Savr tomato has been engineered to “turn off” production of the PG enzyme, slowing the softening process and increasing the tomato’s shelf life.

Genetic engineering technology can also enhance food crops by introducing additional nutrients. Rice, a staple food in many developing countries, does not provide the recommended dietary allowance of several key nutrients including vitamin A. In children, vitamin A deficiency (VAD) is the leading cause of preventable blindness. VAD may also increase the risk and frequency of infections. To address this problem, rice has been modified to produce  $\beta$ -carotene, a precursor of vitamin A. Switching to cultivation of “golden rice” and other nutrient-supplemented crops in these areas represents major progress in combating malnutrition.

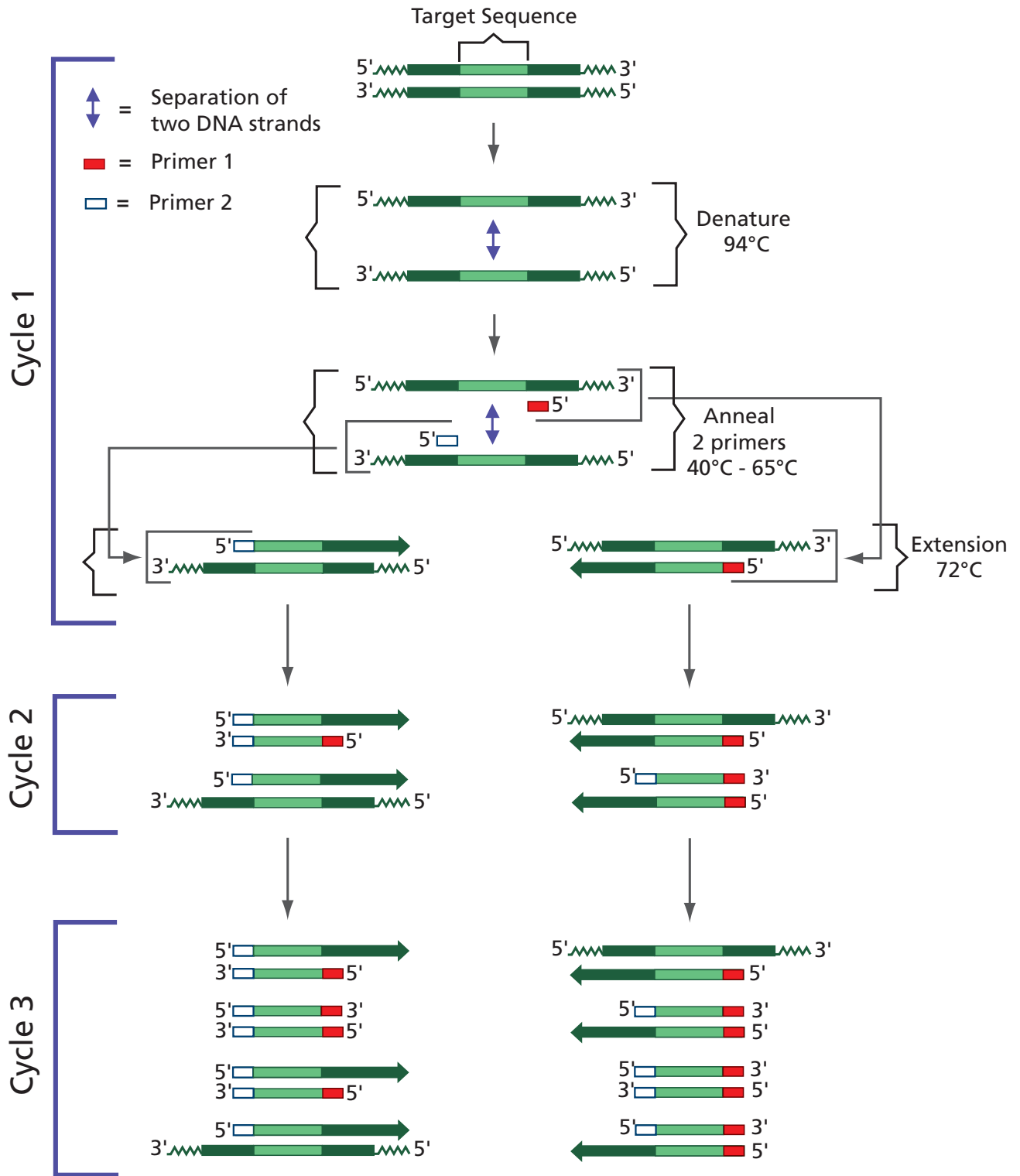
Besides boosting crop yields and enhancing nutrition, transgenic technology could create allergy-free peanuts and low protein rice for people with kidney disease. Genetically modified foods may soon allow for the synthesis and delivery of various pharmaceutical products. In “pharming”, transgenic plants make proteins with medicinal value like insulin or growth hormones. “Pharmaceuticals” can be produced in many crops, including tobacco, carrots, tomatoes, soybeans and rice. Many times, these transgenes are engineered into the chloroplast DNA, which maintains high protein expression levels and is not distributed via pollen. This will generate great amounts of pharmaceuticals with little chance of horizontal gene transfer to surrounding plants.

## ETHICS OF GENETICALLY MODIFIED ORGANISMS

Tomatoes, soybeans and corn were among the first genetically modified food products approved by U.S. agencies in the 1990s. Since then, the safety, efficacy and benefits of GM foods have been debated at a global level. Proponents of GM technology cite studies showing improved quantity and quality of plants, decreasing costs for growers, and benefits for the environment. Critics of GM technology fear the spread of transgenes to other crops, increased allergens, and the creation of unanticipated dangers to people and the environment. Many studies of GMOs and related technologies have been published in leading peer-reviewed science journals like Nature and Science. In 2016, the National Academies of Science, Engineering, and Medicine surveyed 20 years of scientific literature to address concerns about GM technology (available online <http://nas-sites.org/ge-crops/>). While the findings show that current GM technology is safe, it urges caution when introducing any new crop, conventional or GM.



**Figure 3:**  
Insect resistance of  
GM plants.



**Figure 4:**  
Polymerase Chain Reaction.

The responsibility of public health and policy concerning GMOs rests on the shoulders of the government and the biotechnology industry. The United States government has carefully monitored GM food production and created strict regulations to protect the health of Americans. There are three federal agencies in the United States that oversee food safety: the Federal Drug Administration (FDA) monitors the safety of human and animal food products; the U.S. Department of Agriculture (USDA) oversees new plant varieties and their use in farming; and the Environmental Protection Agency (EPA) monitors pesticide levels in plants and determines what is acceptable for human consumption. To gain acceptance, the plant biotechnology industry must communicate the research and development of new GM food products to these agencies.

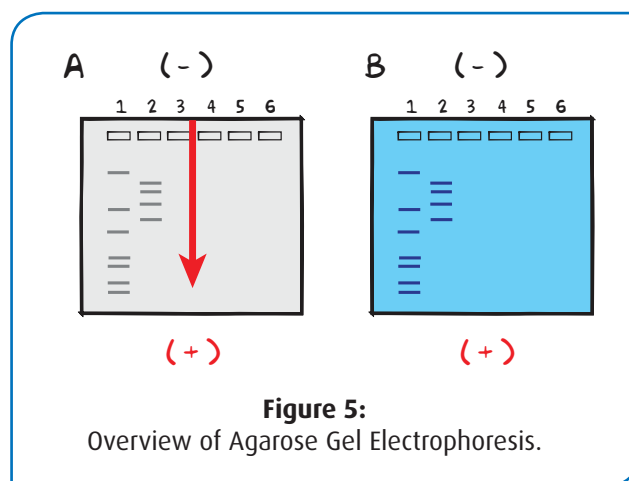
## USING PCR TO IDENTIFY GMOS

To determine whether food products have been genetically engineered, DNA is extracted from the samples and analyzed using the Polymerase Chain Reaction (PCR). This technique has revolutionized biological research because it quickly creates many copies of a specific region of DNA *in vitro*. This is accomplished by using short synthetic DNA molecules (primers) to target specific DNA sequences. In this way, PCR can differentiate between wild-type plants and those that have been genetically engineered by amplifying specific DNA sequences common in GM organisms. The first set of primers target the promoter from the Cauliflower Mosaic Virus (CaMV). Genetic engineers commonly use this promoter because it is recognized by transcriptional machinery of many species of plants. A second set of primers target an insecticide gene isolated from *B. thuringiensis* (*cry1F*). This gene is found in corn, cotton, and sometimes soy. As a positive control for DNA extraction, a plant chloroplast gene is also amplified.

To perform PCR, purified double-stranded DNA is mixed with primers, a thermostable DNA polymerase (*Taq*) and nucleotides (Figure 4). First, the mixture is heated to 94° C to denature the DNA duplex (i.e., unzip it into single strands). Next, the sample is cooled to 45° C-60° C, allowing the primers to base pair with the target DNA sequence (called “annealing”). Lastly, the temperature is raised to 72° C, the optimal temperature at which *Taq* polymerase will extend the primer to synthesize a new strand of DNA. Each “PCR cycle” (denaturation, annealing, extension) doubles the amount of the target DNA in less than five minutes (Figure 4). In order to produce enough DNA for analysis, twenty to forty cycles may be required. To simplify this process, a specialized machine, called a “thermal cycler” or a “PCR machine”, was created to heat and cool the samples rapidly.

After PCR is performed, the samples will contain DNA fragments of different lengths depending upon whether the sample contains genetically modified plants. To analyze the mixture of DNA fragments, scientists use a technique called agarose gel electrophoresis, which separates DNA fragments according to size. The mixture of DNA molecules is added into depressions (or “wells”) within a gel, and then an electrical current is passed through the gel. Because the sugar-phosphate backbone of DNA has a strong negative charge, the current drives the DNA through the gel towards the positive electrode (Figure 5A).

At first glance, an agarose gel appears to be a solid at room temperature. On the molecular level, the gel contains small channels through which the DNA can pass. Small DNA fragments move through these holes easily, but large DNA fragments have a more difficult time squeezing through the tunnels. Because molecules with dissimilar sizes travel at different speeds, they become separated and form discrete “bands” within the gel. After the current is stopped, the bands can be visualized using a stain that sticks to DNA (Figure 5B).





## Experiment Overview

### EXPERIMENT OBJECTIVE:

The objective of this experiment is to utilize PCR to identify genetically modified foods.

### LABORATORY SAFETY:

Be sure to READ and UNDERSTAND the instructions completely BEFORE starting the experiment. If you are unsure of something, ASK YOUR INSTRUCTOR!

- Wear gloves and goggles while working in the laboratory.
- Exercise caution when working in the laboratory – you will be using equipment that can be dangerous if used incorrectly.
- Wear protective gloves when working with hot reagents like melted agarose.
- DO NOT MOUTH PIPET REAGENTS - USE PIPET PUMPS.
- Always wash hands thoroughly with soap and water after working in the laboratory.
- Be sure to properly dispose of any biological samples according to your institutional guidelines.

### LABORATORY NOTEBOOKS:

Scientists document everything that happens during an experiment, including experimental conditions, thoughts and observations while conducting the experiment, and, of course, any data collected. Today, you'll be documenting your experiment in a laboratory notebook or on a separate worksheet.

#### Before starting the Experiment

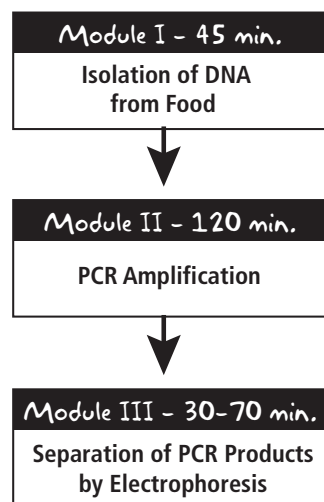
- Carefully read the introduction and the protocol. Use this information to form a hypothesis for this experiment.
- Predict the results of your experiment.

#### During the Experiment

- Record your observations.

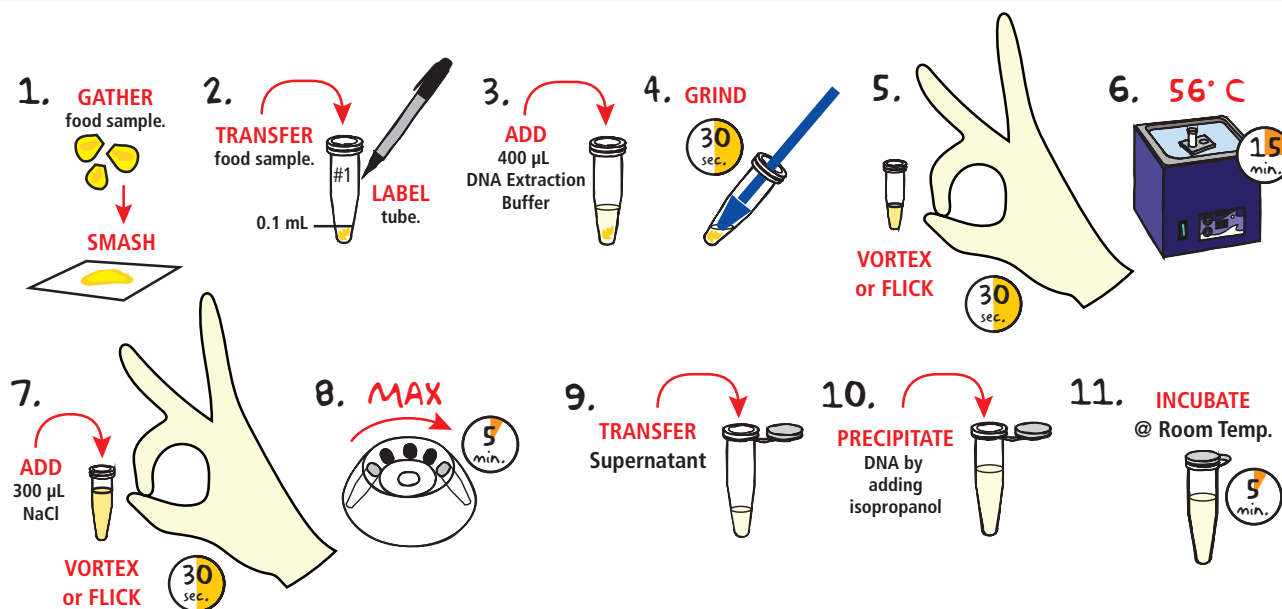
#### After the Experiment

- Interpret the results – does your data support or contradict your hypothesis?
- If you repeated this experiment, what would you change? Revise your hypothesis to reflect this change.



*NOTE: Experimental times are approximate.*

## Module I: Isolation of DNA from Food

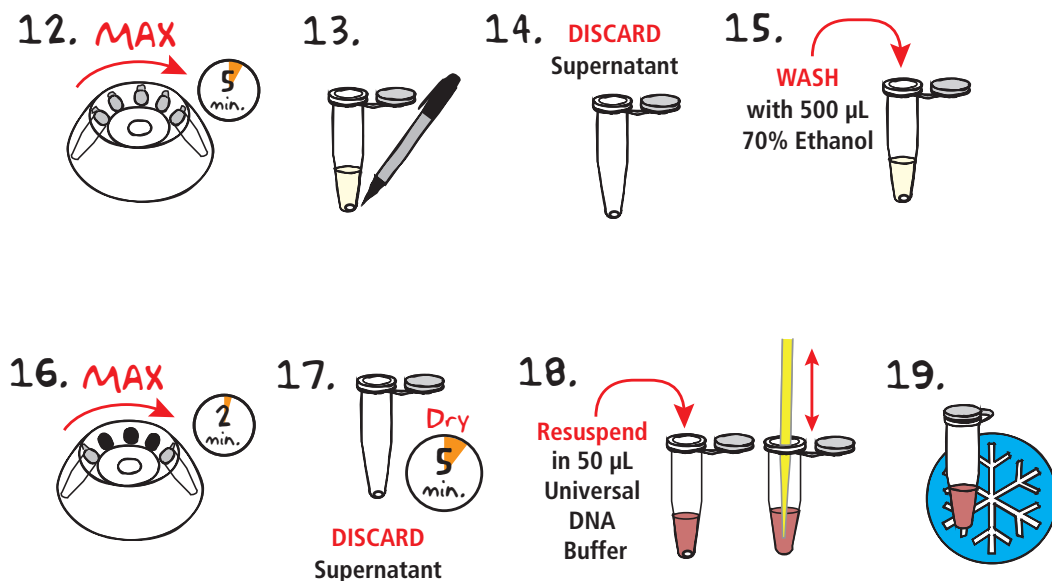


- GATHER** the food sample to be tested. **SMASH** a small amount of food on a clean piece of paper or in a weight boat.
- TRANSFER** enough of the smashed food to a microcentrifuge tube to reach the 0.1 mL mark. **LABEL** the tube with your initials or group number.
- ADD** 400  $\mu\text{L}$  of DNA extraction buffer to the food sample.
- Using a micropestle, **GRIND** the food sample until no large pieces remain (approx. 30 seconds).
- VORTEX** or flick the tubes for 30 seconds to mix the sample.
- INCUBATE** the samples at  $56^{\circ}\text{C}$  for 15 minutes.
- ADD** 300  $\mu\text{L}$  of NaCl solution to the tube and mix well by vortexing or flicking for 30 seconds.
- CENTRIFUGE** the food sample at full speed for 5 minutes.
- Carefully **TRANSFER** the supernatant into a fresh, labeled microcentrifuge tube being careful not to disturb the pellet. **DISCARD** the tubes with pellets.
- PRECIPITATE** the DNA from the supernatant by adding an equal volume of room-temperature isopropanol to the tube. **MIX** well.
- INCUBATE** the tubes at room temperature for 5 minutes.



**OPTIONAL STOPPING POINT:** Store the tube of precipitated DNA and isopropanol at  $-20^{\circ}\text{C}$  if it will not be used immediately.

## Module I: Isolation of DNA from Food, continued

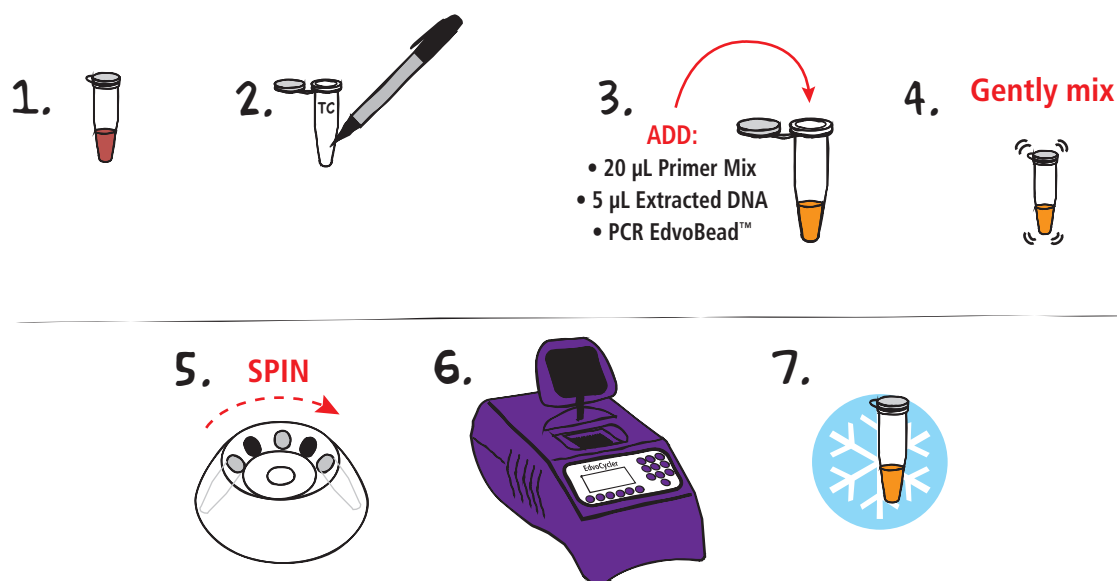


12. **INSERT** the tube in the rotor so that the hinge is facing towards the outside edge. **CENTRIFUGE** the sample at full speed for 5 minutes.
13. After centrifugation, a very small DNA pellet should be visible at the bottom of the hinge side of the tube. **CIRCLE** the location of the DNA pellet with a marker.
14. Carefully **REMOVE** and **DISCARD** the supernatant, leaving the pelleted DNA at the bottom of the tube.
15. **WASH** the pellet by slowly adding 500 µL of 70% Ethanol to the tube.
16. **CENTRIFUGE** the sample at full speed for 2 minutes.
17. Carefully **REMOVE** and **DISCARD** the supernatant and allow the DNA pellet to dry for at least 5 minutes. The pellet should be completely dry.
18. Completely **RESUSPEND** the pellet in 50 µL of Universal DNA Buffer by pipetting up and down several times or by vortexing vigorously.
19. **PLACE** tubes in ice. **PROCEED** to Module II: PCR Amplification.



**OPTIONAL STOPPING POINT:** DNA can be stored at -20° C if it will not be used immediately.

## Module II: PCR Amplification



- OBTAIN** the red extracted DNA from Module I.
  - LABEL** a fresh 0.2 mL PCR tube with the sample's name and your initials.
  - ADD** 20 µL GMO primer mix (yellow), 5 µL extracted DNA (red), and a PCR EdvoBead™ PLUS.
  - MIX** the PCR sample. Make sure the PCR EdvoBead™ PLUS is completely dissolved. If mixed correctly, the final solution will be light orange.
  - CENTRIFUGE** the samples for a few seconds to collect the sample at the bottom of the tubes.
  - AMPLIFY** the DNA using PCR.  
PCR cycling conditions:
    - Initial denaturation 94° C for 5 minutes
    - 94° C for 60 seconds
    - 58° C for 60 seconds
    - 72° C for 60 seconds
    - Final Extension 72° C for 10 minutes
7. After PCR, **PLACE** the tubes on ice. **PROCEED** to Module III: Separation of PCR Products by Electrophoresis.



### OPTIONAL STOPPING POINT:

The PCR samples may be stored at -20° C for electrophoresis at a later time.

### NOTE:

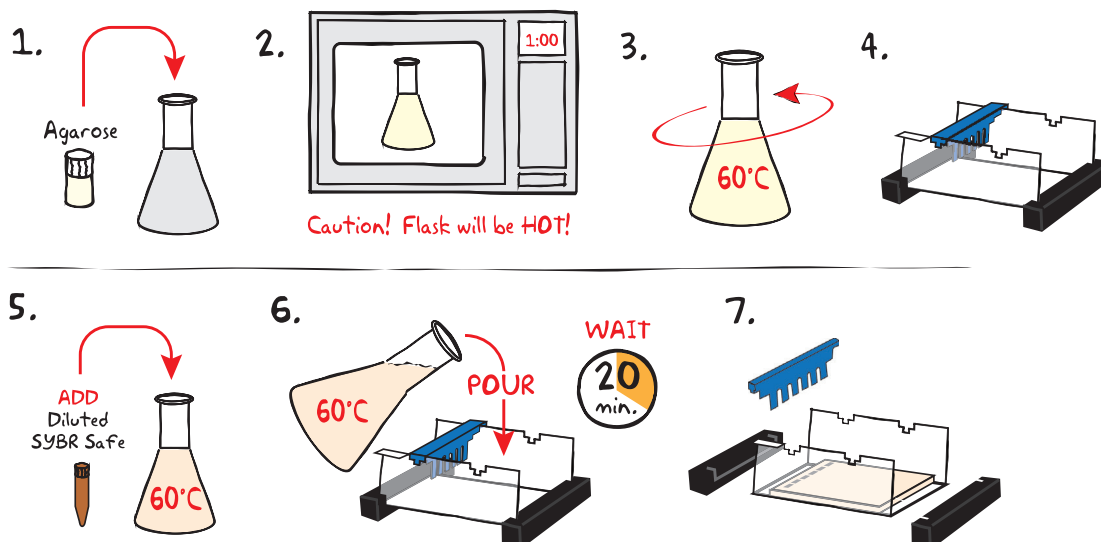
The positive control contains primers, template DNA and PCR components, and is ready for PCR amplification. There are enough control reactions to run 7 per class. At least one control reaction should be run per gel, or one control reaction per 4 student samples. The control reaction should be performed to (a) confirm that the PCR was successful and (b) compare a GMO-positive reference for student samples.



### NOTE:

PCR Cycling Conditions have changed. Please review your PCR program before performing the experiment.

## Module III: Separation of PCR Products by Electrophoresis



### PREPARING THE AGAROSE GEL WITH SYBR® SAFE STAIN

- MIX** the agarose powder with 1X TBE buffer in a 250 mL flask (see Table A).
- DISSOLVE** the agarose powder by boiling the solution. **MICROWAVE** the solution on high for 1 minute. Carefully **REMOVE** the flask from the microwave and **MIX** by swirling the flask. Continue to **HEAT** the solution in 15-second bursts until the agarose is completely dissolved (the solution should be clear like water).
- COOL** agarose to 60° C by carefully swirling the flask to promote even dissipation of heat.
- While agarose is cooling, **SEAL** the ends of the gel-casting tray with the rubber end caps. **PLACE** the comb in the appropriate notch.
- Before casting the gel, **ADD** diluted SYBR® Safe to the cooled molten agarose and swirl the flask to mix (see Table A).
- POUR** the cooled agarose solution into the prepared gel-casting tray. The gel should thoroughly solidify within 20 minutes. The gel will stiffen and become less transparent as it solidifies.
- REMOVE** the end caps and comb. Take particular care when removing the comb to prevent damage to the wells.



Wear gloves  
and safety goggles

#### IMPORTANT:

7 x 7 cm gels are recommended. Each gel can be shared by 4-5 students. Place well-former template (comb) in the first set of notches.

If you are unfamiliar with agarose gel prep and electrophoresis, detailed instructions and helpful resources are available at [www.edvotek.com](http://www.edvotek.com)



#### OPTIONAL STOPPING POINT:

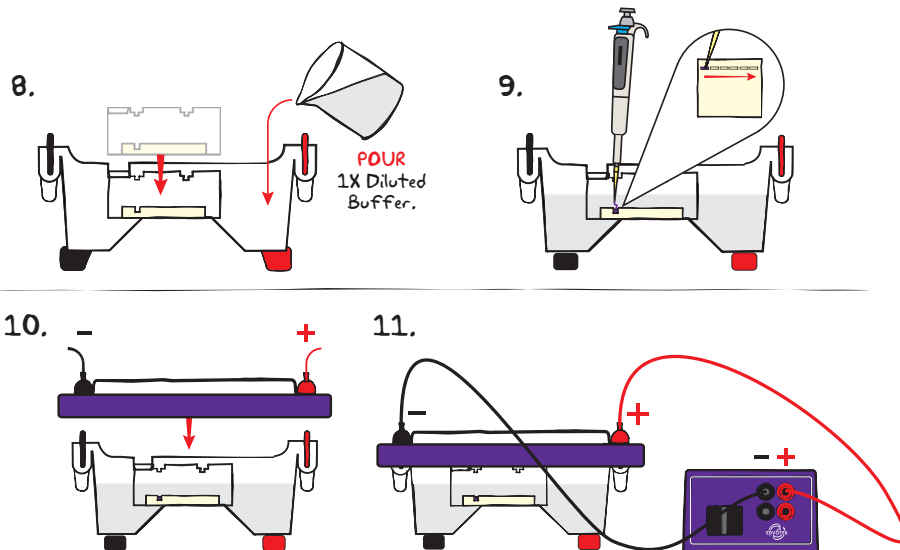
Gels can be stored overnight submerged in electrophoresis buffer, in the fridge, and protected from light.

Table  
A

Individual 2.0% UltraSpec-Agarose™ Gel  
with Diluted SYBR® Safe Stain

Size of Gel Casting tray	1X TBE Buffer	+ Amt of Agarose	= TOTAL Volume	ADD Diluted SYBR (Step 5)
7 x 7 cm	25 mL	0.5 g	25 mL	25 µL
7 x 14 cm	50 mL	1.0 g	50 mL	50 µL

### Module III: Separation of PCR Products by Electrophoresis, continued



**Reminder:**  
Before loading the samples, make sure the gel is properly oriented in the apparatus chamber.



#### RUNNING THE GEL

8. **PLACE** the gel (on the tray) into an electrophoresis chamber. **COVER** the gel with 1X TBE electrophoresis buffer (See Table B for recommended volumes). The gel should be completely submerged.
9. Using Table 1 as a guide, **LOAD** the entire sample (25  $\mu$ L) into the wells in consecutive order.
10. **CHECK** that the gel is properly oriented, then **PLACE** safety cover onto the chamber. Remember, the DNA samples will migrate toward the positive (red) electrode.
11. **CONNECT** the leads to the power source and **PERFORM** electrophoresis (See Table C for time and voltage guidelines).
12. After electrophoresis is complete, **REMOVE** the gel and casting tray from the electrophoresis chamber.



**OPTIONAL STOPPING POINT:**  
Gels can be stored for several days. Protect from light, refrigerate, and keep hydrated by storing each gel in a watertight plastic bag with a small amount of electrophoresis buffer.

Table 1: Sample Table

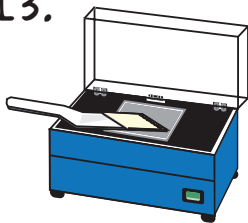
Lane	Recommended	Sample Name
1	100 base pair Ladder	
2	GMO Positive Control	
3	Food Sample 1	
4	Food Sample 2	
5	Food Sample 3	
6	Food Sample 4	

EDVOTEK Model #	Total Volume Required
M6+	300 mL
M12	400 mL
M36	1000 mL

Volts	Time: 7 x 7 cm gel ~4.0 cm migration
75	75 min.
125	40 min.
150	30 min.

### Module III: Separation of PCR Products by Electrophoresis, continued

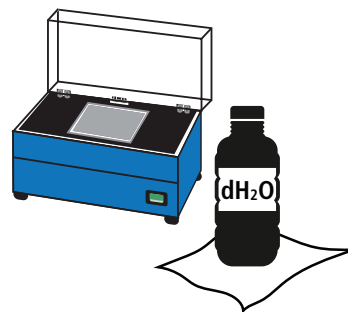
13.



14.



15.



#### VISUALIZING THE SYBR® GEL

13. **SLIDE** the gel off the casting tray onto the viewing surface of the transilluminator and turn the unit on. **ADJUST** the brightness to the desired level to maximize band visualization. DNA should appear as bright green bands on a dark background.
14. **PHOTOGRAPH** the results.
15. **REMOVE** and **DISPOSE** of the gel and **CLEAN** the transilluminator surfaces with distilled water.



Be sure to wear UV goggles if using a UV transilluminator.

## Study Questions

---

1. How are gene guns used in plant genetics? Describe how this technique could be used to create Bt-corn.
2. What are common potential concerns about foodstuffs obtained from GM plants?
3. Which Federal agencies are responsible for oversight on GM plants and foods?
4. What genetic modifications were made to the Flavr Savr tomato? How does this modification affect the tomato?
5. List and describe the three steps of PCR. How can PCR be used to detect genetically modified organisms?



# Instructor's Guide

## OVERVIEW OF INSTRUCTOR'S PRELAB PREPARATION:

This section outlines the recommended prelab preparations and approximate time requirement to complete each prelab activity.

Preparation For:	What to do:	When:	Time Required:
<b>Module I: Isolation of DNA from Food</b>	Thaw DNA extraction buffer.	One day before the experiment.	5 min.
	Prepare and aliquot various reagents.	Up to one day before performing the experiment.	30 min.
	Prepare DNA Extraction Buffer with Proteinase K	Prepare on the day the students will be performing the experiment OR freeze for up to one week.	15 min.
	Equilibrate water baths at 55 ° C and boiling.	Anytime before performing the experiment.	5 min.
<b>Module II: PCR Amplification</b>	Prepare and aliquot various reagents (Primer, DNA template, ladder, etc.).	One day to 30 min. before performing the experiment.	30 min.
	Program Thermal Cycler.	Anytime before performing the experiment.	15 min.
<b>Module III: Separation of PCR Products by Electrophoresis</b>	Prepare TBE buffer and dilute SYBR® Safe Stain.	Up to one week before performing the experiment.	45 min.
	Prepare molten agarose and pour gel.		

Red = Prepare immediately before module.
  Yellow = Prepare shortly before module.
  Green = Flexible / prepare up to a week before the module.

## Pre-Lab Preparations

### MODULE I: ISOLATION OF DNA FROM FOOD

#### Prepare the Reagents:

1. The day before the experiment, place DNA extraction buffer (F) at room temperature to thaw. The buffer can be left out overnight before the experiment.
2. If a white precipitate forms in the DNA extraction buffer, heat to 37° C for 10 minutes to dissolve.

**NOTE:** *The DNA Extraction Buffer must be mixed with Proteinase K before performing the experiment. Once prepared, it should be used the same day or frozen.*

3. Add 200 µL of DNA Extraction Buffer (F) to each tube of Proteinase K and allow the pellets to hydrate for a couple of minutes. Add the dissolved Proteinase K back to the remaining DNA Extraction Buffer and mix. Aliquot 1 mL for each student pair. Keep the tubes on ice.
4. Aliquot 800 µL of NaCl solution (E) for each student pair.
5. Aliquot 110 µL of Universal DNA Buffer (A) for each student pair.
6. The isopropanol and 70% ethanol can be placed at a classroom pipetting station for students to share.

#### Additional Materials:

- Select Foods for DNA extraction. The chart, below, lists recommended foodstuffs that have worked well in the EDVOTEK testing laboratory.
- Each student should receive a microcentrifuge tube and micropestle.

#### NOTE:

We recommend students work in pairs, with each student extracting DNA from their own sample.

#### FOR MODULE I

##### Each Pair should receive:

- 1 mL DNA Extraction Buffer
- 800 µL NaCl solution
- 110 µL Universal DNA Buffer
- 2 microcentrifuge tubes with micropestles
- 2 1.5 mL microcentrifuge tubes with snap tops
- Isopropanol
- 70% Ethanol

Recommended Foods	Not Recommended
<ul style="list-style-type: none"> <li>• Fresh or frozen corn</li> <li>• Fresh or frozen papaya</li> <li>• Fresh or frozen lime beans</li> <li>• Corn bread</li> <li>• Pine nuts</li> <li>• Corn meal</li> <li>• Cake mix</li> <li>• Soy beans</li> <li>• Soy protein-based foods (veggie burgers, hot dogs, soy flour)</li> </ul>	<ul style="list-style-type: none"> <li>• Oatmeal</li> <li>• Potato chips</li> <li>• Corn chips</li> <li>• Breakfast cereals</li> </ul>

## Pre-Lab Preparations

### MODULE II: PCR AMPLIFICATION

The PCR primers are provided as a lyophilized mixture that must be rehydrated by the instructor before performing the experiment. The PCR EdvoBeads™ PLUS can be distributed prior to setting up the PCR – students or instructors can gently transfer the PCR EdvoBeads™ PLUS using gloved hands. Alternatively, beads can be gently "poured" from the vial into individual PCR tubes. After distributing the beads, it is important to close the PCR tubes securely to prevent the beads from absorbing moisture and becoming hard to resuspend prior to the experiment. **NOTE: The PCR EdvoBeads™ PLUS are fragile, use care to not crush the beads while transferring to a PCR tube.**

This kit features the NEW EDVOTEK® LyphoControl™ and LyphoPrimer™. The reagents are also color coded so that a correctly assembled PCR reaction should appear orange in color. These innovations will help ensure experimental success.




#### FOR MODULE II

##### Each Pair should receive:

- 2 PCR EdvoBeads™ PLUS (1 bead per student)
- 2 0.2 mL snap-top PCR tubes
- 1 Tube diluted GMO Primer Mix (50 µL)
- 1 Tube Positive PCR Control

#### Preparation of the GMO Primer Mix:

1. Thaw the TE buffer (B). Mix well before using.
2. Before preparing the primer mix, make sure the solid material is at the bottom of tube of GMO LyphoPrimer™ Mix (C). If not, centrifuge the tube at full speed for 20 seconds or tap the tube on the lab bench.
3. Dilute the GMO LyphoPrimer™ by adding 1 mL of TE Buffer to the tube. Cap and mix well and place on ice. The solution should be clear and yellow in color, and no solid pieces should remain.
4. Pipette 50 µL of the diluted GMO Primer Mix into microcentrifuge tubes. Label these tubes "Primer Mix". Distribute one tube per student pair.

#### Preparation of the Positive PCR Control:

1. Add 190 µL of TE buffer (B) to the tube containing the GMO Positive LyphoControl™ Complete PCR Control (D). Pipette the solution up and down to mix.
2. Pipette 25 µL of the diluted Positive Control into 0.2 mL PCR tubes (one for each positive control reaction). **NOTE: The LyphoControl™ already contains all necessary PCR components and does not need a PCR Edvobead™ PLUS. Once diluted, the LyphoControl™ is ready to be amplified by PCR with the student samples. One LyphoControl™ reaction should be run on every student gel. After PCR, the control reactions can be stored at -20° C until needed in Module III.**

#### Additional Materials:

- Each student should receive one PCR EdvoBead™ PLUS and one 0.2 ml snap-top PCR tube.

#### PCR Amplification:

The Thermal cycler should be programmed as outlined in Module II in the Student's Experimental Procedure.

- Accurate temperatures and cycle times are critical. A pre-run for one cycle (takes approximately 3 to 5 min.) is recommended to check that the thermal cycler is properly programmed.
- For thermal cyclers that do not have a heated lid, it is necessary to place a layer of wax or mineral oil above the PCR reactions in the microcentrifuge tubes to prevent evaporation. Visit [www.edvotek.com](http://www.edvotek.com) for more information.



#### NOTE:

PCR Cycling Conditions have changed. Please review your PCR program before performing the experiment.

## Pre-Lab Preparations

### MODULE III: SEPARATION OF PCR PRODUCTS BY ELECTROPHORESIS

#### Preparation of TBE Electrophoresis Buffer:

For this experiment, we recommend preparing the 1X TBE Electrophoresis Buffer in bulk for sharing by the class. Unused diluted buffer can be used at a later time. See Appendix B for instructions.

#### Preparation of Agarose Gels:

This experiment requires one 2.0% agarose gel per 4 students. **A 7 x 7 cm gel is recommended.** You can choose whether to prepare the gels in advance or have the students prepare their own. Allow approximately 30-40 minutes for this procedure.

#### SYBR® Safe Stain Preparation

Prepare diluted SYBR® Safe by adding 250 µL of 1X TBE buffer to the tube of SYBR® Safe and tapping the tube several times to mix. Diluted SYBR® Safe will be used during agarose gel preparation.

#### Individual Gel Preparation

Each student group can be responsible for casting its own individual gel prior to conducting the experiment (see Module III in the Student's Experimental Procedure). Students will need 1X TBE buffer and agarose powder. In addition, each 7 x 7 cm gel will need 25 µL of diluted SYBR® Safe Stain.

#### Batch Gel Preparation

To save time, a larger quantity of agarose solution can be prepared for sharing by the class (see Appendix B).

#### Preparing Gels in Advance

Gels may be prepared ahead and stored for later use. Solidified gels can be stored for up to 1 week in the refrigerator in water-tight bags with a small amount of buffer to prevent drying. We recommend adding 2 mL of buffer to the bag; excess buffer can lead to diffusion of SYBR® Safe out of the gels.

Do not store gels at -20° C as freezing will destroy them.

Gels that have been removed from their trays for storage should be "anchored" back to the tray with a few drops of molten agarose before being placed into the tray. This will prevent the gels from sliding around in the trays and the chambers.

#### Additional Materials

Each 2.0% gel should be loaded with the 100 base pair ladder and PCR reactions from 3 or 4 foods.

- Pipette 30 µL of the 100 base pair ladder (G) into labeled microcentrifuge tubes and distribute one tube per gel/student group.

#### NOTE:

Accurate pipetting is critical for good experiment results. This experiment is designed for students who have had previous experience with micropipetting techniques and agarose gel electrophoresis.

If students do not know how to use micropipettes, we recommend performing Cat. #S-44, Micropipetting Basics or Cat. #S-43, DNA DuraGel™ prior to conducting this advanced level experiment.

#### FOR MODULE III

##### Each Group should receive:

- 1X TBE Buffer
- UltraSpec-Agarose™ Powder
- Tube of SYBR® Safe (25 µL)
- 100 base pair ladder (30 µL)

#### NOTE:

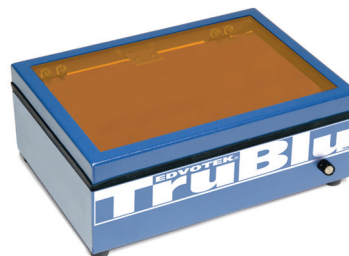
QuickGuide instructions and guidelines for casting various agarose gels can be found on our website.

[www.edvotek.com/quick-guides](http://www.edvotek.com/quick-guides)

Cat. #557

#### TruBlu™ LED Transilluminator

The all-new TruBlu™ LED Transilluminator utilizes blue light to view DNA gels stained with SYBR® Safe, thus eliminating the need for UV light or ethidium bromide. The spacious viewing area fits multiple agarose gels. And the high intensity control and orange lid ensure superior visualization.

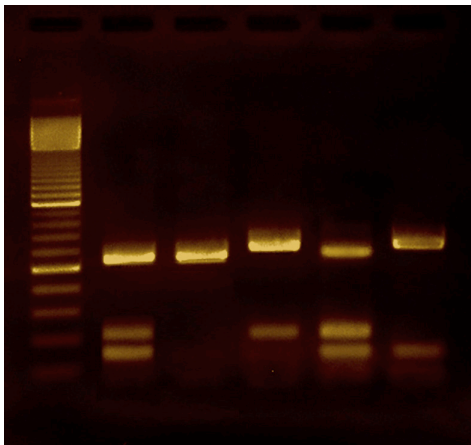


#### Features:

- 14.5 x 18 cm viewing area
- Blue light intensity control
- Orange contrast lid
- Durable steel casing
- Made in the USA

## Experiment Results and Analysis

In this experiment, results will vary depending upon the type of genetic modification (if any) in the food source chosen by the student(s). Successful genomic DNA purification from foodstuffs can have a significant impact on the PCR amplification and gel electrophoresis results. Poor results and quality of extracted genomic DNA can be caused by an unsuccessful extraction attempt. For optimal DNA preparation, particular attention should be paid to the extraction process as described in the protocol.



Lane	Sample	Analysis
1	100 base pair Ladder	—————
2	GMO Positive Control	500 bp plant chloroplast, 200 bp CMV 35s, and 125 bp Cry1F
3	GMO Negative Foodstuff	500 bp plant chloroplast
4	Soy Beans Extraction	500 bp plant chloroplast and 200 bp CMV 35s
5	Corn Bread Extraction	500 bp plant chloroplast, 200 bp CMV 35s, and 125 bp Cry1F
6	Papaya Extraction	500 bp plant chloroplast and 125 bp Cry1F

**NOTE:** Depending on the PCR conditions used, a diffuse, small-molecular weight band, known as a "primer dimer", may be present below the 100 bp marker. This is a PCR artifact and can be ignored. Other minor bands may also appear due to nonspecific primer binding and the subsequent amplification of these sequences.

**Please refer to the kit  
insert for the Answers to  
Study Questions**

# Appendices

- A EDVOTEK® Troubleshooting Guide
- B Bulk Preparation of Electrophoresis Buffer and Agarose Gels

Safety Data Sheets:

Now available for your convenient download on [www.edvotek.com/Safety-Data-Sheets](http://www.edvotek.com/Safety-Data-Sheets)

## EDVO-TECH Service

**1.800.EDVOTEK**

Mon. - Fri. 8am-5:30pm EST



### Please Have the Following Info:

- Product Number & Description
- Lot Number on Box
- Order/Purchase Order #
- Approx. Purchase Date

Fax: 202.370.1501 • [info@edvotek.com](mailto:info@edvotek.com) • [www.edvotek.com](http://www.edvotek.com)

**[www.edvotek.com](http://www.edvotek.com)**

- Online Catalog
- Order Products
- Experiment Protocols
- Tech Support
- Resources!



[1.800.EDVOTEK](tel:1800EDVOTEK) • Fax [202.370.1501](tel:2023701501) • [info@edvotek.com](mailto:info@edvotek.com) • [www.edvotek.com](http://www.edvotek.com)

Duplication of any part of this document is permitted for non-profit educational purposes only. Copyright © 1989-2018 EDVOTEK, Inc., all rights reserved. 962.181010



## Appendix A

### EDVOTEK® Troubleshooting Guides

#### DNA EXTRACTION

PROBLEM:	CAUSE:	ANSWER:
<b>Poor DNA Extraction.</b>	Samples not mixed or smashed well enough during extraction.	In addition to flicking the tube, vortex or pipet up and down to mix the sample.
	Proteinase K inactive because it was prepared too far in advance.	Prepare Proteinase K within one hour of use.
	Water baths not at proper temperature.	Use a thermometer to confirm water bath set point.
	Not enough DNA.	Extracting DNA from food products can be challenging. Refer to page 18 for food sample recommendations.
	Too much sample during extraction.	Use only enough sample to reach the 0.1 mL mark in the microcentrifuge tube.
<b>The extracted DNA is very cloudy.</b>	Cellular debris from pellet transferred to tube.	Centrifuge sample again and move supernatant to a fresh tube. Take care to avoid pellet.
	Cellular debris not separated from supernatant.	Centrifuge sample again. If possible, centrifuge at a higher speed. Move cleared supernatant to a fresh tube.



## Appendix A

### EDVOTEK® Troubleshooting Guides

#### PCR AND ELECTROPHORESIS

PROBLEM:	CAUSE:	ANSWER:
There is very little liquid left in tube after PCR.	Sample has evaporated.	<p>Make sure the heated lid reaches the appropriate temperature.</p> <p>If your thermal cycler does not have a heated lid, overlay the PCR reaction with wax (see <a href="http://www.edvotek.com">www.edvotek.com</a> for details).</p> <p>Make sure students close the lid of the PCR tube properly.</p>
	Pipetting error.	Make sure students pipet 20 $\mu$ L primer mix and 5 $\mu$ L extracted DNA into the 0.2 mL tube.
The ladder, control DNA, and student PCR products are not visible on the gel.	The gel was not prepared properly.	Ensure that the electrophoresis buffer was correctly diluted.
		Gels of higher concentration (> 0.8%) require special attention when melting the agarose. Make sure that the solution is completely clear of "clumps" and glassy granules before pouring gels.
	The proper buffer was not used for gel preparation. Make sure to use 1x Electrophoresis Buffer.	
	The gel was not stained properly.	Repeat staining.
	Malfunctioning electrophoresis unit or power source.	Contact the manufacturer of the electrophoresis unit or power source.
After staining the gel, the DNA bands are faint.	The gel was not stained for a sufficient period of time.	Repeat staining protocol.
After staining, the ladder and control PCR products are visible on the gel but some student samples are not present.	Student DNA sample was not concentrated enough.	Poor DNA extraction. Repeat Module I (Isolation of DNA from food).
	Student DNA sample was degraded.	If DNA is not used right after extraction, store sample at -20°C.
	Wrong volumes of DNA and primer added to PCR reaction.	Practice using micropipettes.
Some student samples have more/less amplification than others.	Concentration of DNA varies by sample.	There is an inherent variability in the extraction process.
Low molecular weight band in PCR samples.	Primer dimer.	Low concentration of extracted DNA in PCR reaction.
DNA bands were not resolved.	To ensure adequate separation, make sure the tracking dye migrates at least 3.5 cm on 7 x 7 cm gels and 6 cm on 7 x 14 cm gels.	Be sure to run the gel the appropriate distance before staining and visualizing the DNA.

## Appendix B

### Bulk Preparation of Electrophoresis Buffer and Agarose Gels

To save time, the electrophoresis buffer and agarose gel solution can be prepared in larger quantities that the whole class can share. Leftover diluted buffer can be used at a later time and solidified agarose gel solution can be remelted.

#### BULK 1X TBE ELECTROPHORESIS BUFFER

For this experiment, we recommend preparing the 1X TBE Electrophoresis Buffer in bulk for sharing by the class. Unused diluted buffer can be used at a later time.

1. Measure 3.7 L of distilled or deionized water and place in a large vessel. (**NOTE: If using purchased water in a gallon jug, remove and discard 80 mL water.**)
2. Add the entire amount of TBE Electrophoresis Buffer powder to the vessel and mix well.
3. Label the vessel as "1X TBE Electrophoresis Buffer".
4. Use within 60 days of preparation.

#### BATCH AGAROSE GELS (2.0%)

Bulk preparation of 2.0% agarose gel is outlined in Table D.

1. Measure 250 mL of 1X TBE Electrophoresis Buffer and pour into a 500 mL flask.
2. Pour 5.0 g of UltraSpec-Agarose™ into the prepared buffer. Swirl to disperse clumps.
3. With a marking pen, indicate the level of solution volume on the outside of the flask.
4. Heat the agarose solution as outlined previously for individual gel preparation. The heating time will require adjustment due to the larger total volume of gel buffer solution.
5. Cool the agarose solution to 60° C with swirling to promote even dissipation of heat. If evaporation has occurred, add distilled water to bring the solution up to the original volume as marked on the flask in step 3.
6. If staining with SYBR® Safe, add the entire volume of diluted SYBR® Safe from page 20 to the cooled agarose and mix well.
7. Dispense the required volume of cooled agarose solution for casting each gel. Measure 25 mL for each 7 x 7 cm gel, 50 mL for each 7 x 14 cm gel. **For this experiment, 7 x 7 cm gels are recommended.**
8. Allow the gel to completely solidify. It will become firm and cool to the touch after approximately 20 minutes. Then proceed with preparing the gel for electrophoresis. Alternatively, gels can be stored in water-tight plastic bags with 2 mL of 1X electrophoresis buffer for up to 1 week in the refrigerator.

Table D	
Batch Prep of 2.0% UltraSpec-Agarose™	
Amt of Agarose	+ 1x TBE Electrophoresis Buffer
5.0 g	250 mL

#### Note:

The UltraSpec-Agarose™ kit component is usually labeled with the amount it contains. Please read the label carefully. If the amount of agarose is not specified or if the bottle's plastic seal has been broken, weigh the agarose to ensure you are using the correct amount.

#### NOTE:

QuickGuide instructions and guidelines for casting various agarose gels can be found on our website. [www.edvotek.com/quick-guides](http://www.edvotek.com/quick-guides)